

## *Notice de pose pour volet coulissant \*\*\*option targette ronde\*\*\**

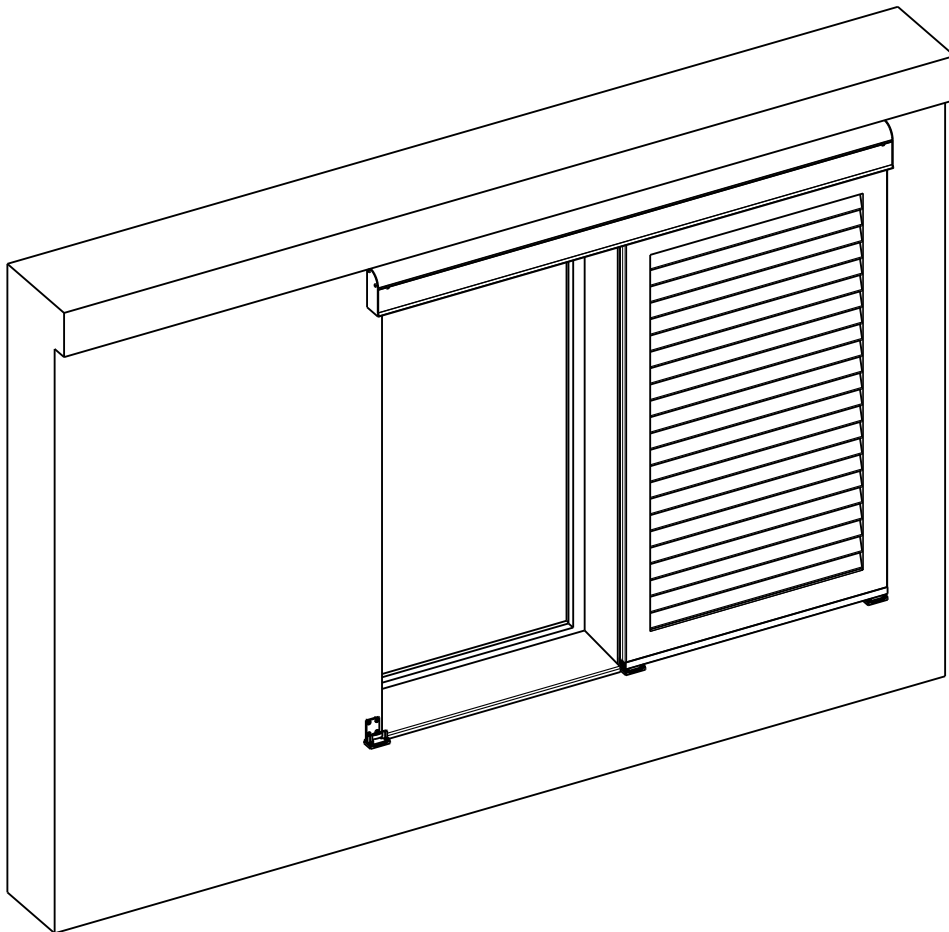

## Matériel fourni

Ø 3            N2

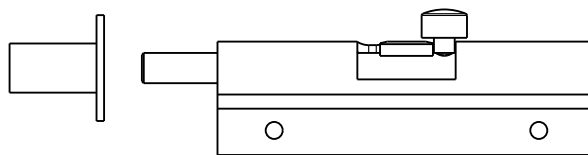
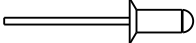
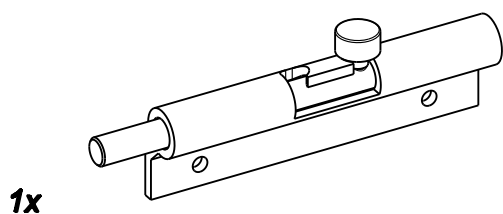
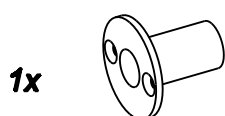

## Matériel non fourni

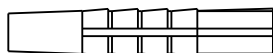

## Outillage nécessaire

**EHRET** 

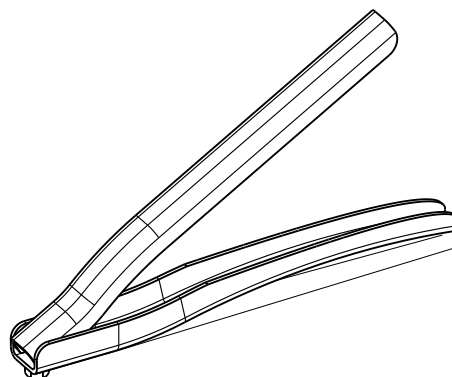
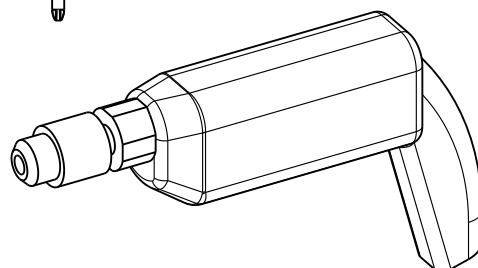
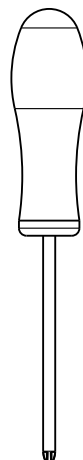

foret Ø 3,2mm

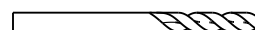

foret Ø 13,5mm

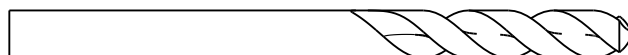

Mèche à béton

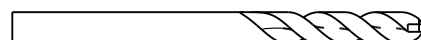

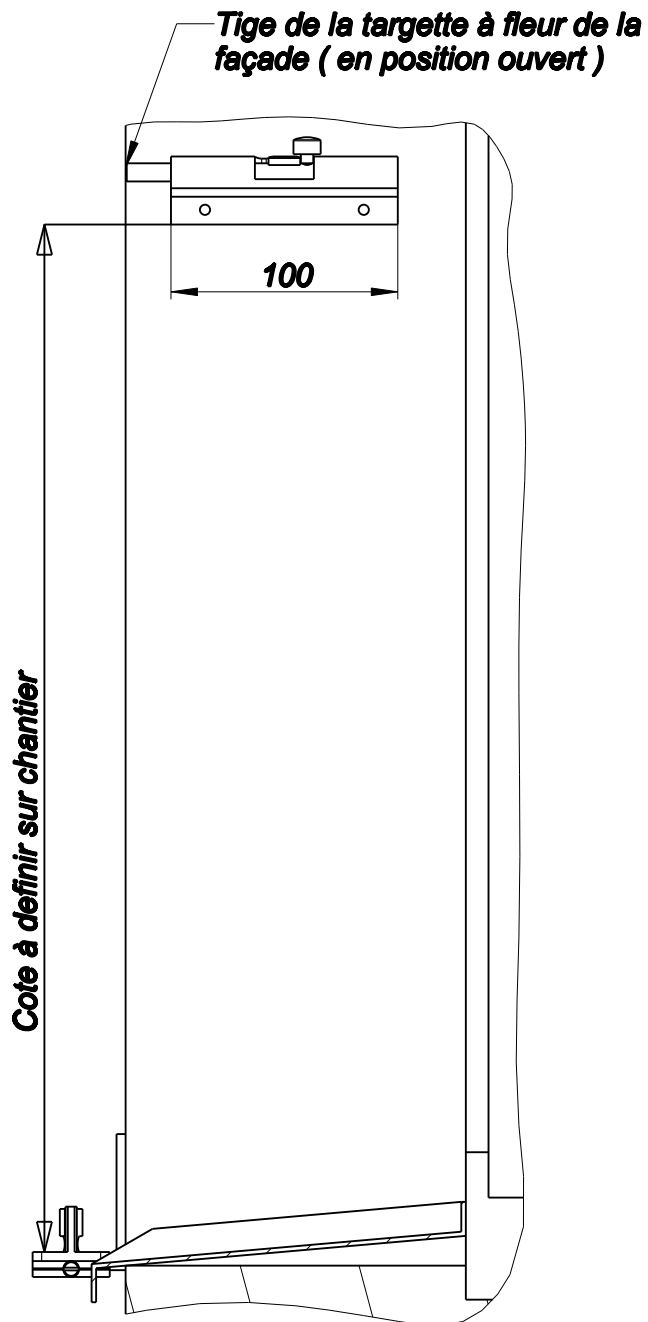

**Matériel non fourni**

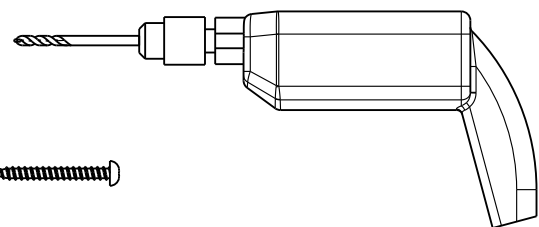
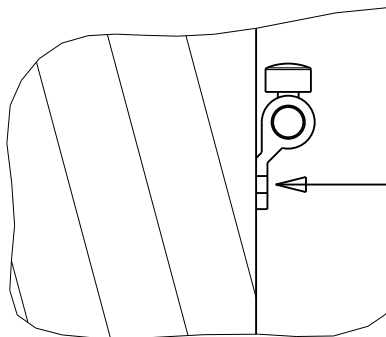
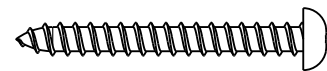

**Les éléments de fixation doivent être choisis en fonction de la structure du support!**

## Traçage et perçage de la douille

1. Amener le volet en position fermé.
2. Tracer l'axe de perçage.

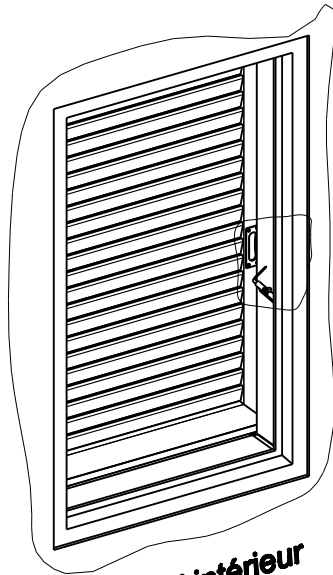

*Vue de l'intérieur*

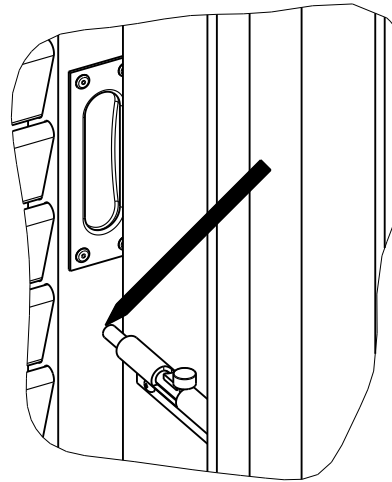

3. Faire un avant trou.
4. Percer au  $\varnothing 13,5$  mm.

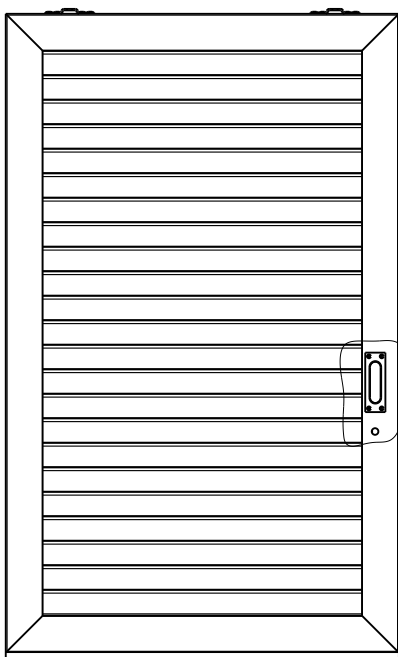

*Vue de l'intérieur*

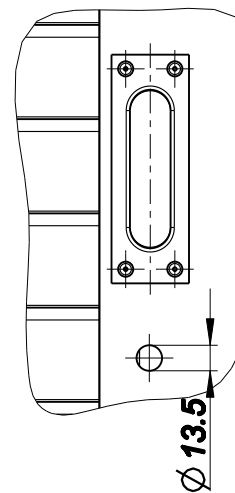

$\varnothing 13.5$

foret  $\varnothing 13,5$ mm

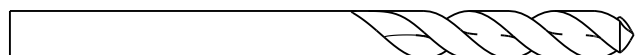

## 1. Insérer la douille.

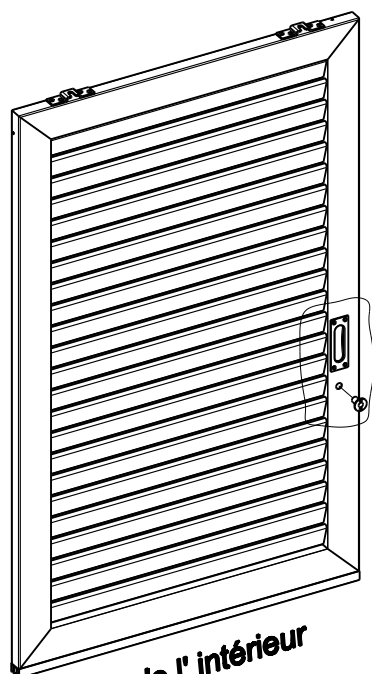

Vue de l'intérieur

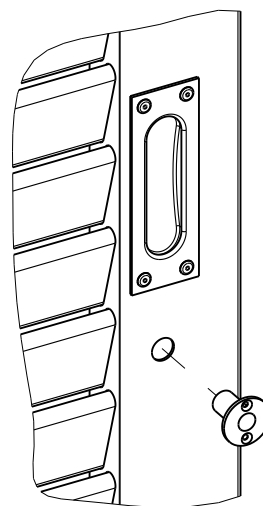

## 2. Aligner la douille, percer.

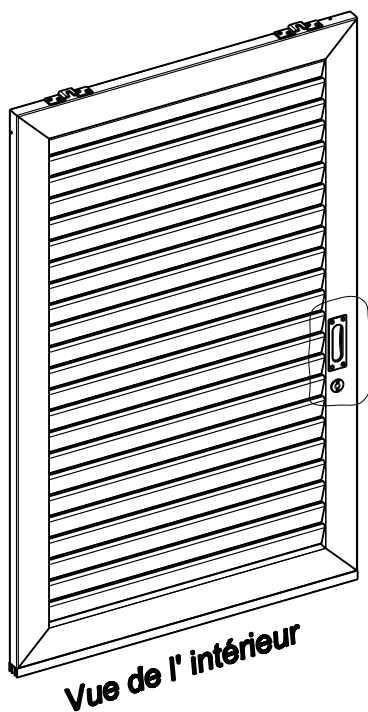

Vue de l'intérieur

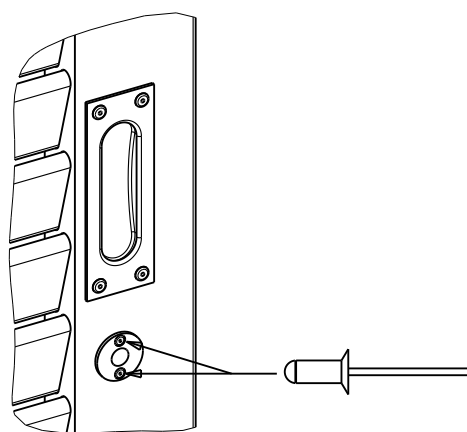

foret  $\varnothing$  3,2mm

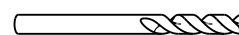

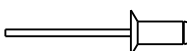
N2 

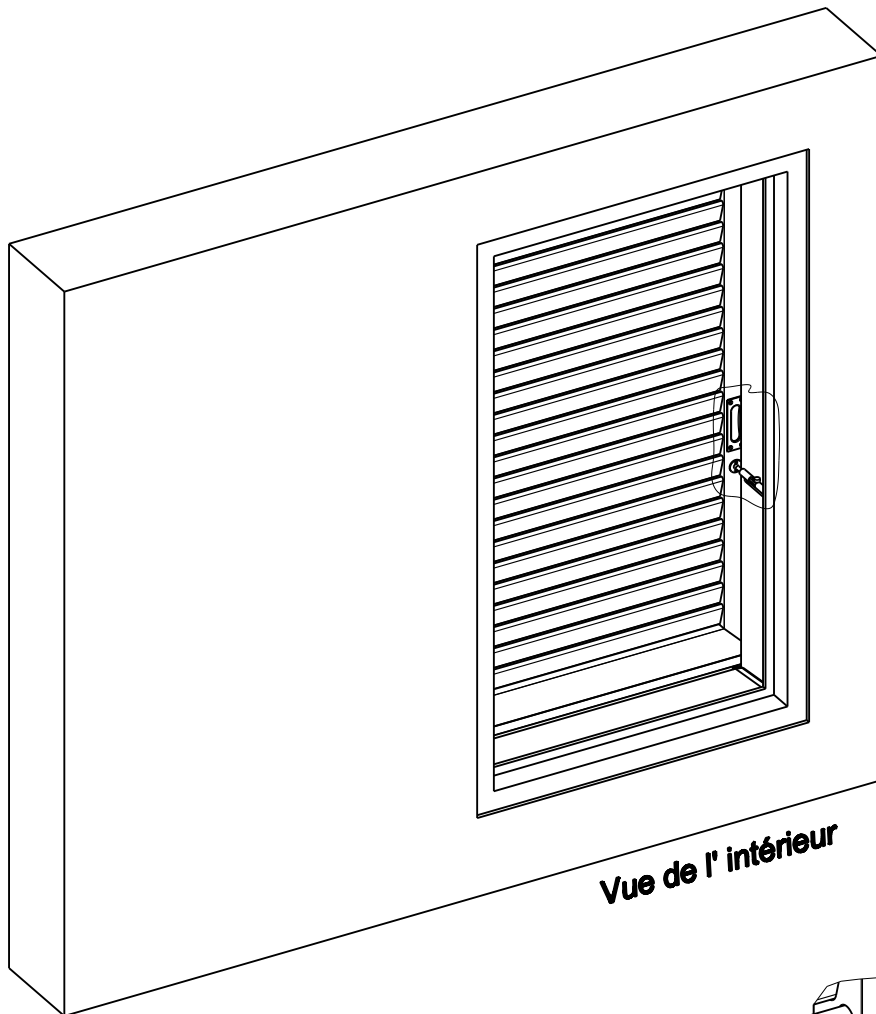

**Vue de l'intérieur**

