



Sliding shutter control

Aluminium shutters



Operating and main- tenance instructions

FOR THE USER
Valid from 09.2011

E 916.3

Notes

These operating instructions describe how to operate the EHRET sliding shutter control. It is essential to install the sliding shutter system in accordance with the specifications laid out in the installation instructions for EHRET sliding shutters before commissioning the sliding shutter control.

These operating and maintenance instructions are a component part of the product and are therefore always to be retained until the product is disposed of. These operating and maintenance instructions are to be passed along in the event of the sale of this product. These instructions are addressed to the users of the EHRET sliding shutter drives.

This product complies with the general rules of technology. Safety-conscious behaviour is necessary for commissioning the product safely. For this reason, observe the following notes.

Carefully read through these instructions prior to commissioning. Observe the specified process steps and take into account the notes and recommendations given.

Knowledge of and technically impeccable implementation of the given safety notes and warnings are prerequisites for safe and proper operation of the EHRET sliding shutter control. Insufficient knowledge at the time of commissioning and utilisation lead to the loss of any liability claims against EHRET GmbH. Installation and/or operation in full or partial deviation from our installation and operating instructions will lead to the warranty for defects becoming void.

Should any of the information in these operating and maintenance instructions not be absolutely clear, it is essential that you contact your EHRET dealer.

Contents

Notes	2
Explanation of symbols and characters	4
Safety notes	4
Maintenance notes.	5
In the event of a power failure	6
Spare parts and repairs.	6
Incorrect operation.	6
Dismantling.	6
Disposal	7
Warranty	7
CE EC Declaration of Conformity	8
1 Product description	
Sliding shutter drive	9
Technical data	9
2 Operation	
Operating the control	11
Keeping the shutters open and closed.	11
Performing a normal movement	11
Creep travel	11

Explanation of signs and symbols

DANGER

- ▶ Designates an imminent danger that could lead to death or severe injuries if the respective precautionary measures are not implemented.

WARNING

- ▶ Means that death, severe bodily injury or major property damage could occur if the respective precautionary measures are not implemented.

CAUTION

- ▶ Means a possible danger that could lead to minor injuries or property damage if it is not avoided.

- ▶ Directives for action

Only operate the sliding shutter control once you are thoroughly familiar with the contents of these instructions!

Safety notes

WARNING

- ▶ Take into account the following notes and warnings in order to avoid dangers and to protect the product.
- ▶ Electrical work may be carried out only by authorised electricians.
- ▶ The specified connection diagrams are to be observed, as otherwise damage to the motor could occur. EHRET assumes no liability for damage resulting from incorrect installation.
- ▶ Do not touch any internal parts of the product that become exposed as the result of damage (e.g. electrical cables/lines). In such cases, you must notify your EHRET dealer.
- ▶ Discontinue operation of your electrical drive at once in the event of smoke or fumes. Notify your EHRET dealer.
- ▶ Do not allow children to play with the operating apparatus of the sliding shutter drives.
- ▶ Electrical/electronic devices are not secure against failure. Make sure that no hazardous situations for personnel or product could arise in the event of a power failure.
- ▶ Devices with electrical controls could go into motion at any time and without warning. Prevent situations hazardous to personnel and product that arise from this fact.
- ▶ No personnel or obstacles are permitted to be within the range of pivoting and/or travelling shutters in normal operation. Keep personnel and objects away until the shutters have reached their final position.
- ▶ Do not reach into moving parts or closing areas while shutters are opening/closing.



Maintenance notes

- ▶ Disconnect the drives from the power supply during maintenance work.
- ▶ Make sure that no articles of clothing or body parts are able to be caught by moving parts in the system.
- ▶ Ice could form on the product in the event of snowfall, sleet or icy rain. Do not operate equipment until the ice formation is no longer present, and switch automatic controls to manual.
- ▶ Make sure that the shutters are locked before any wind load occurs.
- ▶ The shutters may not be operated at wind speeds from 62 km/h (stormy wind).
- ▶ No additional loads such as persons or objects are permitted to have an effect on the shutters.
- ▶ Shutters are not intended to protect individuals from falls.

CAUTION

Danger of crushing from moving sliding sashes.

- ▶ Personnel, animals and objects must not be in the path of the sliding shutter system.

 DANGER	
	Danger of death from electric shock
<ul style="list-style-type: none"> ▶ If electrical parts are undergoing maintenance or inspection, the drive must be disconnected from the power and secured against re-connection. 	

 WARNING	
Danger of injury due to lack of regular maintenance	
<ul style="list-style-type: none"> ▶ Regularly check the sliding shutter system for signs of damage or wear. Systems which require repairs must no longer be used. 	

<i>NOTE</i>	
<ul style="list-style-type: none"> ▶ EHRET sliding shutter drives must undergo maintenance regularly, i.e. at least once per year. ▶ All inspection and maintenance work may only be carried out by an EHRET dealer. 	

Necessary maintenance work



- ▶ Check the drive for visible wear or for damage to the motor housing, motor cable, rail connection or cable pulleys.
- ▶ Carry out a functional test.



In the event of a power failure

IMPORTANT

Deletion of reference position due to power failure

A power failure can delete the reference position. Observe the following procedure after a power failure:

- ▶ Move the sliding sash(es) toward the motor to the final position by using the  OPEN or  CLOSE BUTTON. In this position, the control detects the reference position required for normal operation.

If the sliding sashes are already located in this reference position during the power failure, it is still necessary to briefly move the sliding sashes back and forth using the  OPEN or  CLOSE button!

- ▶ This ensures all moving functions are in order.

Spare parts and repairs



CAUTION

Injury to personnel or damage to property arising from incorrect repairs

- ▶ Repairs must only be carried out by your EHRET dealer.

- In order to ensure that your folding shutters remain functional in the long term, only original EHRET spare parts may be used. If necessary, contact your EHRET dealer.

Incorrect operation

Correct operation can no longer be ensured if the position of the sliding shutter is moved by hand quickly and with great force, and not by means of operation with the  OPEN or  CLOSE button.

In such cases, a force may be applied to the sliding shutter in such a way that the current mechanical position of the sliding shutter no longer matches the position indicated on the control.

This leads to incorrect information within the control, as a result of which the control will no longer function correctly.

- ▶ This condition is rectified as a rule by running the shutter up and down again.

Dismantling

CAUTION

Injury to personnel or damage to property arising from incorrect dismantling

- ▶ Dismantling must only be carried out by your EHRET dealer.

- ▶ Dismantling and new installation of the product must be carried out by a specialised company in accordance with the current guidelines and standards. Any missing documents must always be requested from an EHRET dealer before beginning dismantling or new installation.
- ▶ Dispose of any product which has become unusable in accordance with the applicable statutory regulations.

Disposal



IMPORTANT

Disposal

- The following information must be strictly adhered to in order to prevent any environmental damage. Even if the machine is disposed of by certified experts, the operator must ensure proper execution!

Some materials are reusable. By recycling some parts or raw materials from used products, you make an important contribution to protecting the environment.

- ▶ Please contact your local authorities if you require information about collection points near you.

Recyclable materials

Reusable material	Components
Aluminium	<ul style="list-style-type: none"> • Sliding shutters • Suspensions • Guide bracket • Window sill cover • Fittings
Copper	<ul style="list-style-type: none"> • Cables • Motor
Plastic, rubber, PVC	<ul style="list-style-type: none"> • Guides • Accessories • Seals • Cables
Steel	<ul style="list-style-type: none"> • Motor and components • Fittings • Accessories



IMPORTANT

Disposal

- ▶ Dispose of any machine parts in such a way that damage to human health and the environment can be excluded.

Hazardous waste

Reusable material	Components
Electronic waste	<ul style="list-style-type: none"> • Electrical supplies • Controls • Circuit boards with electronic components

Warranty

- The statutory limitation period shall apply for warranty claims. This is predicated on the provision of regular maintenance.
- Wear and tear parts such as gears, bearings, pulley wheels, steel cables and supplied fittings are excluded from the warranty.

CE EC Declaration of Conformity

(Original EC Declaration of Conformity)

In accordance with Machinery Directive 2006/42/EC, Annex II, 1. A.

In accordance with EMC Directive 2004/108/EC

In accordance with Low Voltage Directive 73/23/EEC

In accordance with the Construction Products Directive 89/106/EEC

The manufacturer: EHRET GmbH
Aluminium shutters
Bahnhofstrasse 14-18
77972 Mahlberg, Germany

declares that the product: **EHRET sliding shutter drive**
Description of function: Drive to actuate sliding shutters

meets all the applicable requirements of the EC Directives specified above.
The following harmonised standards have been applied in full:

Equipment safety EN 61010-1:2002-08, Amendment 1 (2002-11), Amendment 2 (2004-01), EN 13659:2009-01, DIN EN 12045:2000-12

Electromagnetic compatibility EN 61000-6-1:2007-10, EN 61000-6-2:2006-03, EN 61000-6-3:2007-09, EN 61000-6-4:2007-09

Immunity EN 61000-3-2:2005-09, EN 61000-3-3:2002-05, EN 61000-4-2:2001-12, EN 61000-4-3:2008-03, EN 61000-4-4:2005-07, EN 61000-4-6:2008-04, EN 61000-4-5:2007-06, EN 61000-4-8:2009-10, EN 61000-4-11:2005-02

Transient emissions EN 55016-2-1:2006-05, EN 55016-2-3:2007-0

—

Name and address of the individual who is authorised to assemble the technical documentation:

Ralf Gielen
Head of Technology

Location: 77972 Mahlberg, Germany
Date: 01.01.2015

EHRET GmbH
Andreas Schnaase
Head of Sales

EHRET GmbH
Eberhard Schopferer
Management

Sliding shutter drive

The EHRET sliding shutter drive is a drive with integrated control for the actuation of sliding shutters.

- Configurable running speed
- Electronic locking in end position
- Programming of the pick-up position of double bars and acceleration or delay of the running speed at the beginning, the end and in the carriage range.
- Creep travel upon reaching the beginning and end positions

Technical Data

<i>Standby</i>	< 0,5W
<i>Max. motor power</i>	approx. 30W
<i>IP type of protection</i>	IP54
<i>Temperature range</i>	-20° C to +60° C
<i>Timeout duration</i>	
Teach-in run	approx. 420 sec
Normal operation	approx. 240 sec
<i>Speeds</i>	
Level 1	approx. 2.5 cm/sec
Level 2	approx. 3.5 cm/sec
Level 3	approx. 4.5 cm/sec
Level 4	approx. 5.5 cm/sec

<i>Torque duration</i>	0.42 Nm 100% ED
<i>Short-term permissible torque</i>	0.9 Nm < 1 sec
<i>Force detection</i>	Internal speed measuring system (speedometer)
<i>Motor gearbox</i>	Transmission ratio 111: 1
<i>Power reserve</i>	approx. 100–150 runs

A Voletronic 230 V | Serial push-button operation

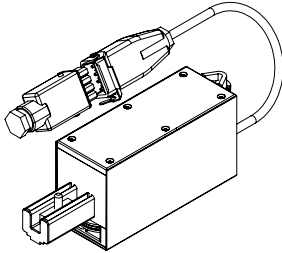

<i>Power supply</i>	85 VAC–265 VAC, 50/60 Hz
<i>Connection cable</i>	Hirschmann plug, 5-pin

B Voletronic 230 V | Wireless remote control

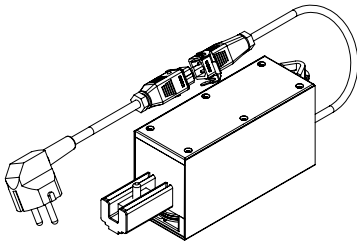

<i>Power supply</i>	85 VAC–265 VAC, 50/60 Hz
<i>Connection cable</i>	Hirschmann plug, 3-pin
<i>Radio frequency</i>	868 MHz RC-01
<i>Radio range approx.</i>	100 m (free field)

C Voletronic Solar 12 V | Wireless remote control

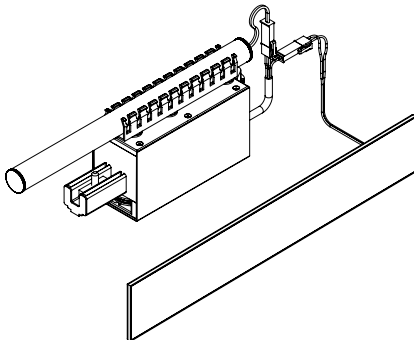

<i>Power supply</i>	12 V / DC solar
<i>Battery</i>	LiFePO4 battery 12.8 V, 1250 mAh
<i>Radio frequency</i>	868 MHz RC-01
<i>Radio range approx.</i>	100 m (free field)

Operating the control

- The sliding shutter system with sliding shutter control has been installed and commissioned by your EHRET dealer according to the EHRET GmbH specifications.
- During operation, the control system determines and processes technical information which is measured by respective sensors. Therefore, it is possible to adapt the sliding shutter drive to your system's special structural conditions. This adjustment has already been carried out by the manufacturer or your EHRET dealer.

Keeping the shutters open and closed

Keeping the shutters open

If the sliding shutter system is opened completely, the sliding shutters are automatically held in this open position. This locking mechanism is electronic rather than mechanical.



Keeping the shutters closed





If the sliding shutter system is completely closed, all sliding shutters are automatically held in this closed position. This locking mechanism is electronic rather than mechanical.

Partially open/closed

If the sliding shutter system is only partially open or closed, the sliding shutter is not automatically held in this position. The sliding shutter can be moved by applying gentle force (e.g. manually pushing the shutter).

Performing a normal movement

The  OPEN or  CLOSE BUTTON can be used to move the sliding shutter in the "open" and/or "closed" direction. There are 2 available operating modes:

- Briefly pressing a button (less than 3 seconds) moves the sliding shutter in the corresponding direction to the end of the object. Pressing the  OPEN or  CLOSE BUTTON again stops the moving sliding shutter.
- Pressing and holding the  OPEN or  CLOSE BUTTON (longer than 3 seconds) moves the sliding shutter in the corresponding direction to the end of the object. As the control only detects the press-and-hold action after three seconds, the shutter only starts to move after three seconds have elapsed. Releasing the button stops the sliding shutter from moving.

Creep travel

When the sliding shutter reaches the start/end position

In order to prevent the sliding shutter slamming in the start or end positions while it is moving in these directions, the control automatically switches to creep travel 150 mm before these positions are reached.

In the pick-up positions of multi-part sliding systems

In order to prevent the sliding sashes that are pulled along mechanically from rocking, the control reduces the speed in the area of the pick-up position of the double bars.

EHRET GmbH

Aluminium shutters

Bahnhofstrasse 14–18

77972 Mahlberg, Germany

Tel. + 49 (0) 78 22/439-0

Fax + 49 (0) 78 22/439-116

www.ehret.com