

PROVENCE

Aluminium folding shutter



Order form
and planning tool

Distribution diagrams

The stop diagrams are sketched as if viewed from inside.

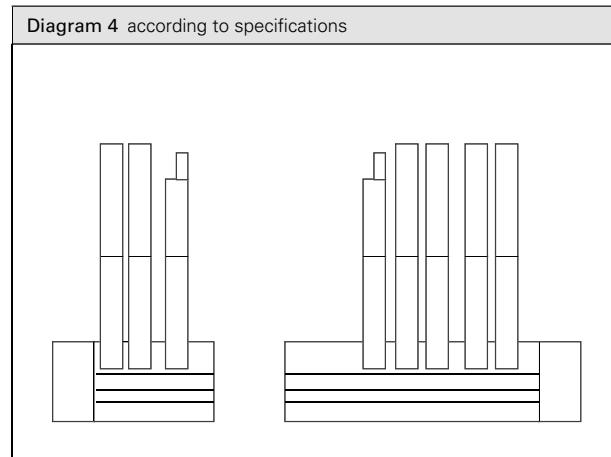
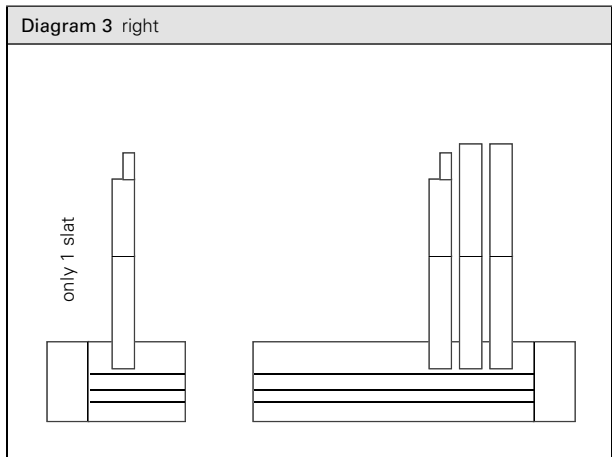
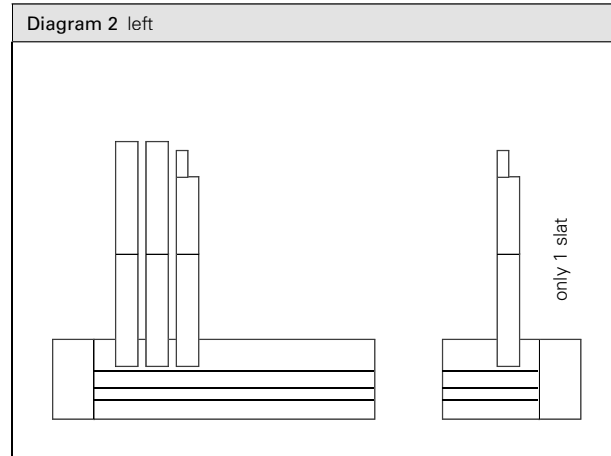
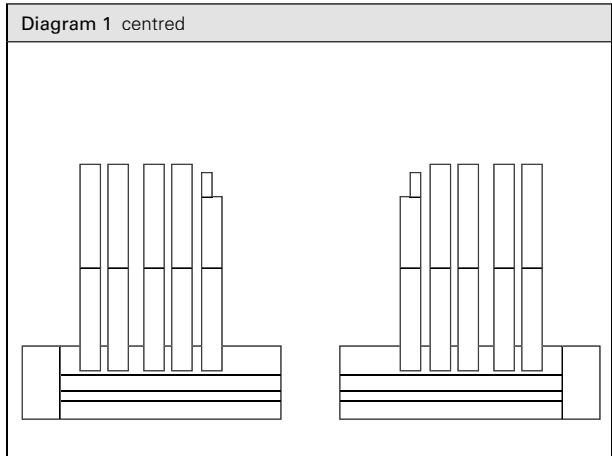

Measuring instructions | Provence folds outwards

Standard arrangement

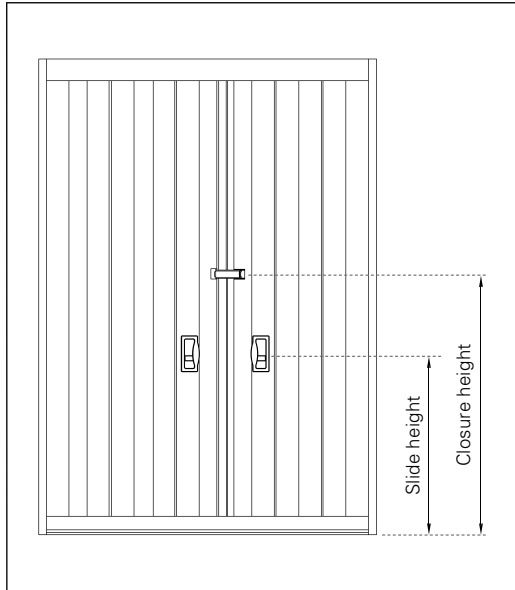

Vertical cross-section

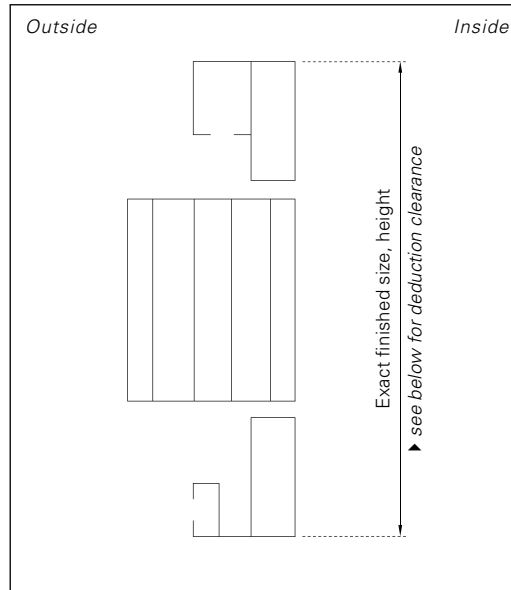

Horizontal cross-section

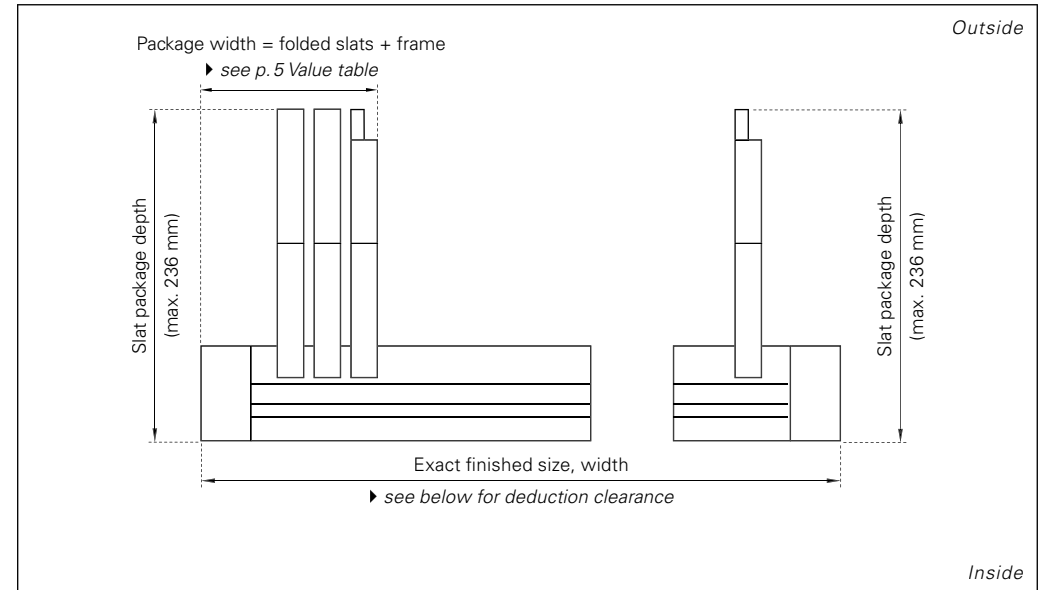

- Outside view

Element height	Slide height	Closure height
0–1200 mm	180 mm	central
1200–1800 mm	500 mm	670 mm
1800–2500 mm	1000 mm	1170 mm

- Deviating heights on request!

⚠ Deduction clearances (taken into consideration by EHRET)

without opener	W: -8 mm	H: -8 mm
with opener	W: -14 mm	H: -30 mm

- The specified deduction clearances are taken into consideration as standard.

Measuring instructions | Provence folds inwards

Standard arrangement

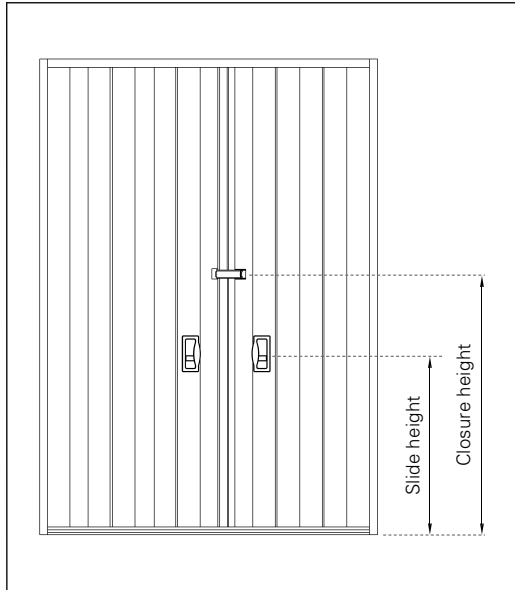

Vertical cross-section

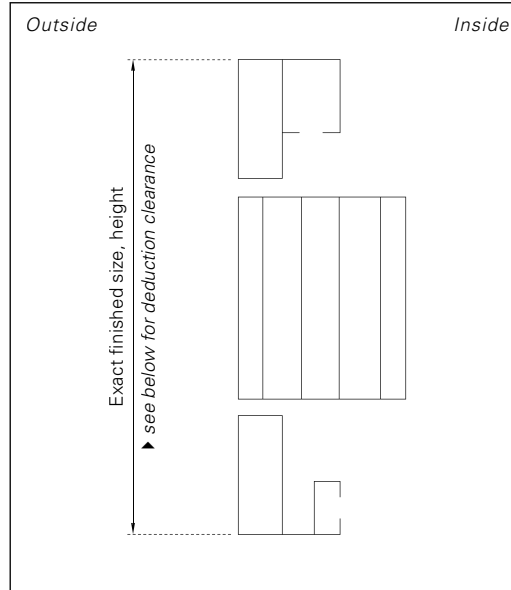

Horizontal cross-section

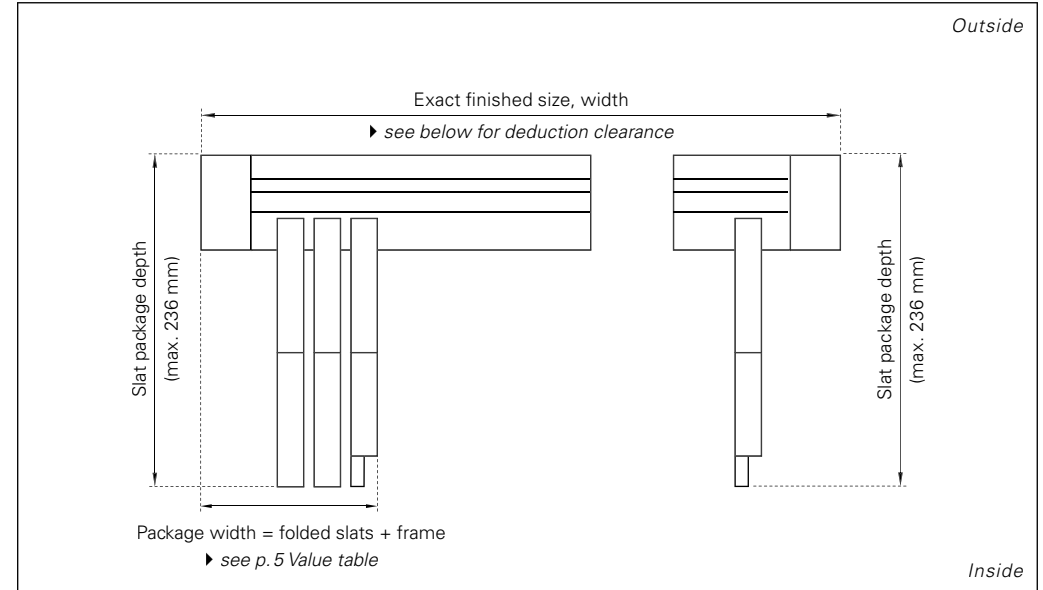

- Outside view

Element height	Slide height	Closure height
0–1200 mm	180 mm	central
1200–1800 mm	500 mm	670 mm
1800–2500 mm	1000 mm	1170 mm

INFO

- cannot be combined with Rod lock
- cannot be combined with Openers

- Deviating heights on request!

Measuring instructions | Rod lock Provence

Standard arrangement

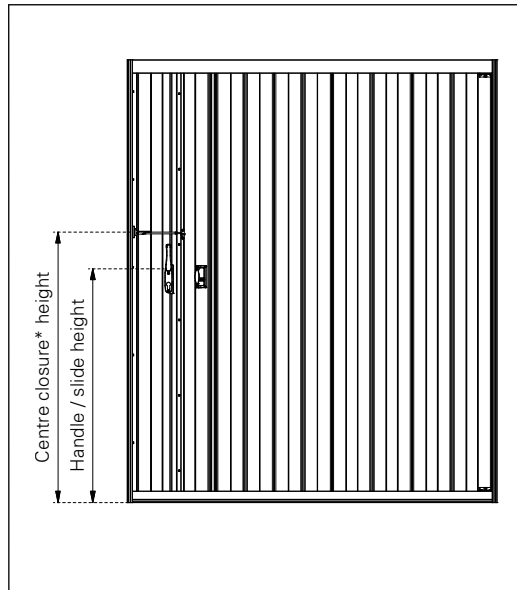

*Centre closure supplied loose

Element height	Slide height	Closure height
0–1200 mm	180 mm	Self-installation
1200–1800 mm	500 mm	Self-installation
1800–2500 mm	1000 mm	Self-installation

⚠ Deduction clearances (taken into consideration by EHRET)		
without opener	W: -8 mm	H: -8 mm
with opener	W: -14 mm	H: -30 mm

Vertical cross-section

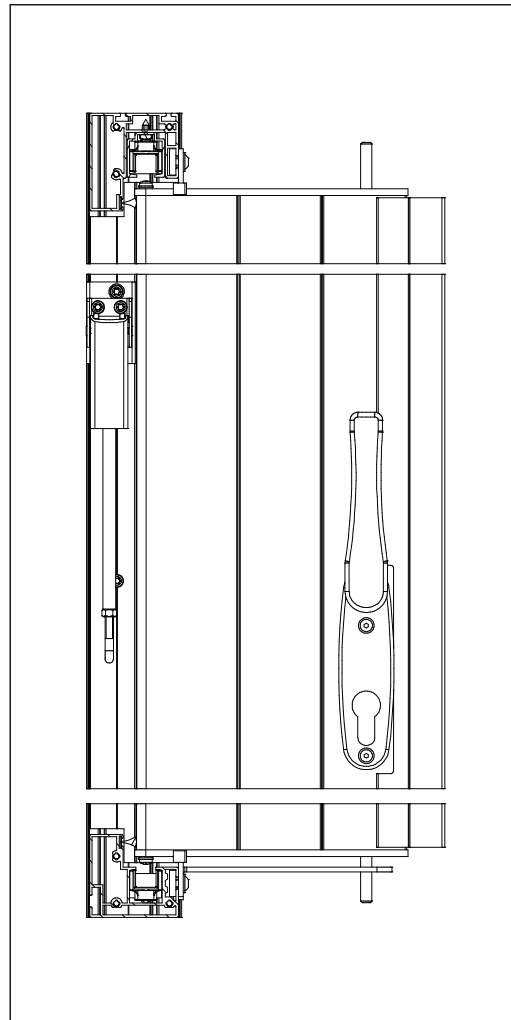

Horizontal cross-section

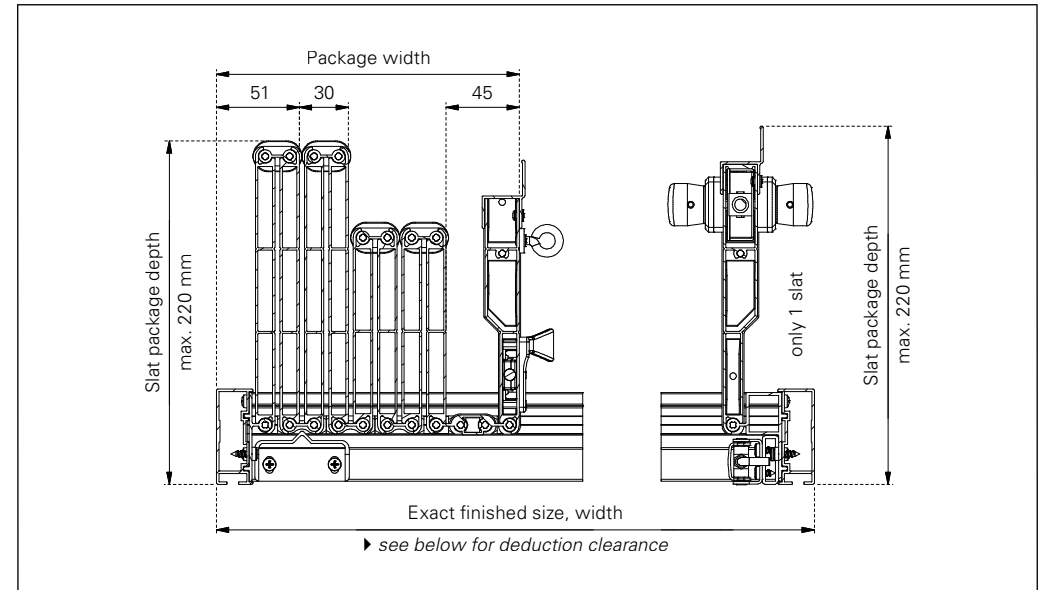

• The specified deduction clearances are taken into consideration as standard.

Standard distribution

The specified widths are reference values. The package width and the number of slats may change depending on the width and reveal depth.

Value table

Width	Max. number of slats, left	Max. package width, left	Max. number of slats, right	Max. package width, right
600	3	70	3	70
700	3	70	3	70
800	5	100	3	70
900	5	100	3	70
1000	5	100	3	70
1100	5	100	5	100
1200	5	100	5	100
1300	7	130	5	100
1400	7	130	5	100
1500	7	130	5	100
1600	7	130	7	130
1700	7	130	7	130
1800	7	130	7	130
1900	9	160	7	130
2000	9	160	7	130
2100	9	160	9	160
2200	9	160	9	160
2300	9	160	9	160
2400	11	190	9	160
2500	11	190	9	160
2600	11	190	9	160
2700	11	190	11	190
2800	11	190	11	190
2900	13	220	11	190
3000	13	220	11	190

- Wider folding shutters are possible as special constructions, but only on request.

Options

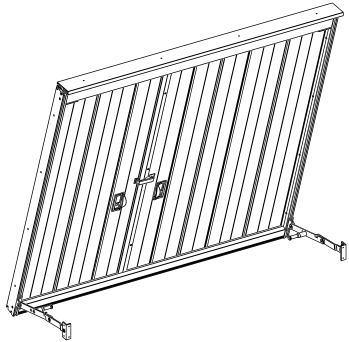

Two-handed opener
Hinge profiles, coated,
2 opener scissors, coated,
for self-installation

Width max.: 1500 mm
Width min.: 600 mm
Height max.: 1500 mm
Height min.: 800 mm

8641

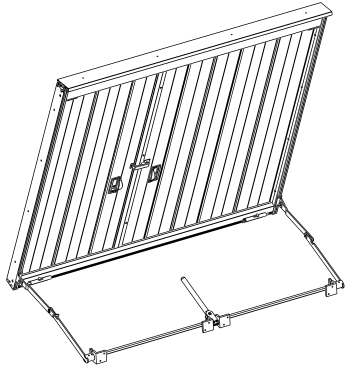

One-handed opener
Hinge profiles, coated,
2 opener scissors, coated, connecting rod
and one-handed lever,
for self-installation

Width max.: 2000 mm
Width min.: 600 mm
Height max.: 1500 mm
Height min.: 800 mm

8642

Deduction clearances (from EHRET):

Width: -14 mm
Height: -30 mm

The specified deduction clearances are taken into consideration as standard.

Maximum sizes for opener

	600	700	800	900	1000	1100	1200	1300	1400	1500	1600	1700	1800	1900	2000	2100
600																
700																
800																
900																
1000																
1100																
1200																
1300																
1400																
1500																
1600																
1700																
1800																
1900																
2000																
2100																

Element height in mm

element width in mm

- One-handed / two-handed openers are possible
- One-handed opener is possible

Options

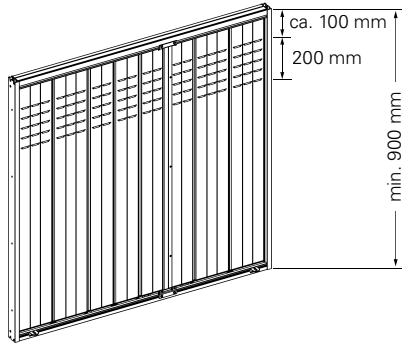

5 air vents
embossed on both sides,
grid 50 mm

8610

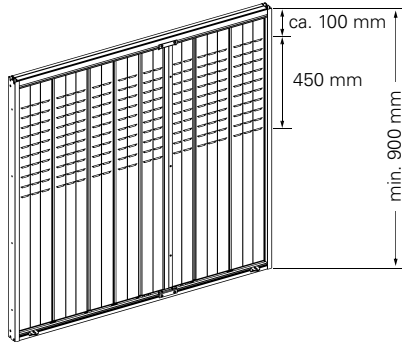

10 air vents
embossed on both sides,
grid 50 mm

8611

INFO

- The air vent option is available for folding shutters at a height of at least 900 mm.
- Air vents with 60-slat and 100-slat not possible.
- Air vents in middle slats only possible if technically feasible.

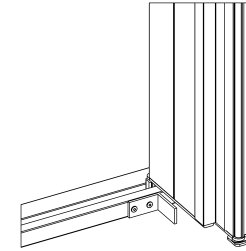

Lower guide, barrier-free
version without brush seal,
height 20 mm

8849

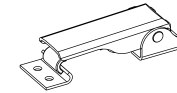
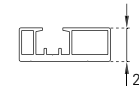

Additional centre lock
Folding shutter

8725

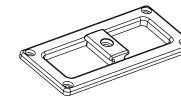

Additional slide with handle cover

downwards 8643

(as standard from a width of 1801 mm)

upwards 8644

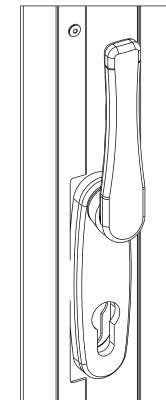

Rod lock PROVENCE

concealed installation, with profile cylinder,
handle and centre closure rod lock Provence,
operable on both sides

8820

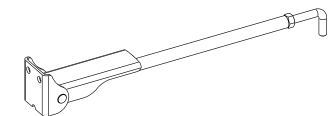

Centre closure
Rod lock PROVENCE

8821

Order form | PROVENCE | Folding shutters

Date _____ Page _____ of _____ Consignment _____
 Your address and signature _____
 Preferred delivery date _____
 Your customer number _____ Ocean Line plus yes
 Your processor _____

OFFER ORDER

Surface _____ Colour system _____ Colour n° _____
 Element FSM RAL
 Wood finish NCS
 Various VSR

Info _____ Width _____ Height _____
 Deduction clearances: - 8mm - 8mm
 With opener: - 14mm - 30mm



Tel. +49(0)78 22/439-0
 Fax +49(0)78 22/439-217
 www.ehret.com

 Follow-up order
 The original order no. must be specified in the event of follow-up deliveries:

▶ Deduction clearances are taken into consideration by EHRET as standard

Item	Quantity	Distribution diagram	folds outwards	folds inwards	Clear dimensions ▶ see Info on 'deduction clearances'		Available reveal	Additional options					Options				Miscellaneous	
					Width	Height		Deviating closure height	Barrier-free	Downwards slide	Upwards slide	Centre lock	2-handed opener	1-handed opener	Air vents 250 mm	Air vents 450 mm		Rod lock
			<input type="checkbox"/>	<input type="checkbox"/>					<input type="checkbox"/>	<input type="checkbox"/>	<input type="checkbox"/>	<input type="checkbox"/>	<input type="checkbox"/>	<input type="checkbox"/>	<input type="checkbox"/>	<input type="checkbox"/>	<input type="checkbox"/>	
			<input type="checkbox"/>	<input type="checkbox"/>					<input type="checkbox"/>	<input type="checkbox"/>	<input type="checkbox"/>	<input type="checkbox"/>	<input type="checkbox"/>	<input type="checkbox"/>	<input type="checkbox"/>	<input type="checkbox"/>	<input type="checkbox"/>	
			<input type="checkbox"/>	<input type="checkbox"/>					<input type="checkbox"/>	<input type="checkbox"/>	<input type="checkbox"/>	<input type="checkbox"/>	<input type="checkbox"/>	<input type="checkbox"/>	<input type="checkbox"/>	<input type="checkbox"/>	<input type="checkbox"/>	
			<input type="checkbox"/>	<input type="checkbox"/>					<input type="checkbox"/>	<input type="checkbox"/>	<input type="checkbox"/>	<input type="checkbox"/>	<input type="checkbox"/>	<input type="checkbox"/>	<input type="checkbox"/>	<input type="checkbox"/>	<input type="checkbox"/>	
			<input type="checkbox"/>	<input type="checkbox"/>					<input type="checkbox"/>	<input type="checkbox"/>	<input type="checkbox"/>	<input type="checkbox"/>	<input type="checkbox"/>	<input type="checkbox"/>	<input type="checkbox"/>	<input type="checkbox"/>	<input type="checkbox"/>	
			<input type="checkbox"/>	<input type="checkbox"/>					<input type="checkbox"/>	<input type="checkbox"/>	<input type="checkbox"/>	<input type="checkbox"/>	<input type="checkbox"/>	<input type="checkbox"/>	<input type="checkbox"/>	<input type="checkbox"/>	<input type="checkbox"/>	
			<input type="checkbox"/>	<input type="checkbox"/>					<input type="checkbox"/>	<input type="checkbox"/>	<input type="checkbox"/>	<input type="checkbox"/>	<input type="checkbox"/>	<input type="checkbox"/>	<input type="checkbox"/>	<input type="checkbox"/>	<input type="checkbox"/>	
			<input type="checkbox"/>	<input type="checkbox"/>					<input type="checkbox"/>	<input type="checkbox"/>	<input type="checkbox"/>	<input type="checkbox"/>	<input type="checkbox"/>	<input type="checkbox"/>	<input type="checkbox"/>	<input type="checkbox"/>	<input type="checkbox"/>	
			<input type="checkbox"/>	<input type="checkbox"/>					<input type="checkbox"/>	<input type="checkbox"/>	<input type="checkbox"/>	<input type="checkbox"/>	<input type="checkbox"/>	<input type="checkbox"/>	<input type="checkbox"/>	<input type="checkbox"/>	<input type="checkbox"/>	
			<input type="checkbox"/>	<input type="checkbox"/>					<input type="checkbox"/>	<input type="checkbox"/>	<input type="checkbox"/>	<input type="checkbox"/>	<input type="checkbox"/>	<input type="checkbox"/>	<input type="checkbox"/>	<input type="checkbox"/>	<input type="checkbox"/>	
			<input type="checkbox"/>	<input type="checkbox"/>					<input type="checkbox"/>	<input type="checkbox"/>	<input type="checkbox"/>	<input type="checkbox"/>	<input type="checkbox"/>	<input type="checkbox"/>	<input type="checkbox"/>	<input type="checkbox"/>	<input type="checkbox"/>	

EHRET GmbH

Bahnhofstrasse 14-18

D-77972 Mahlberg

Tel. +49(0) 78 22/439-0

Fax +49(0) 78 22/439-116

www.ehret.com

Made in Germany

© 07.2019 EHRET GmbH | F05.E | Subject to technical modifications