

## Schnellzarge Z75

Montagerahmen / Zargen



Bestellformular  
und Planungshilfe

# Anschlagschemen

Ansichten jeweils von innen!

Abzugsmaße werden von uns standardmäßig berücksichtigt.

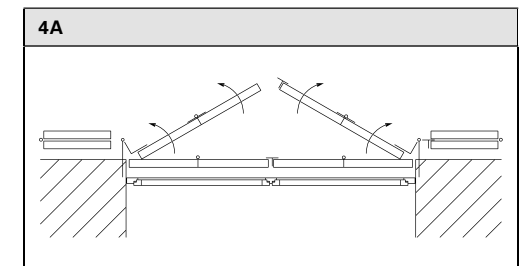
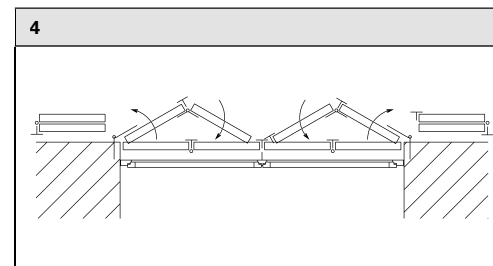
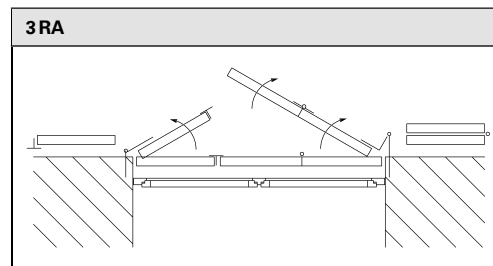
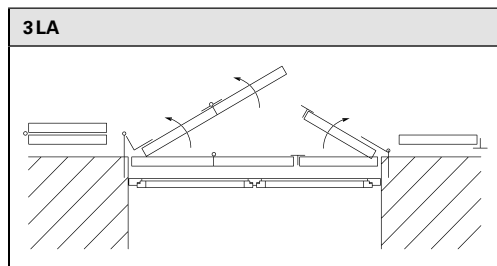
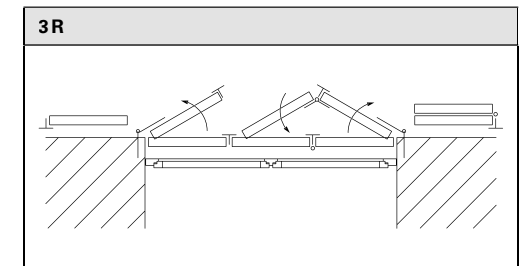
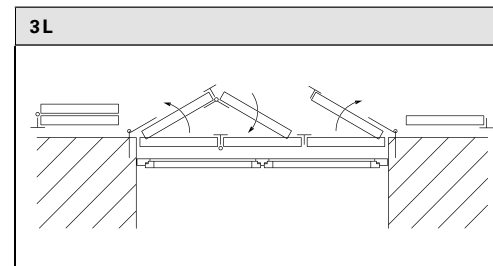
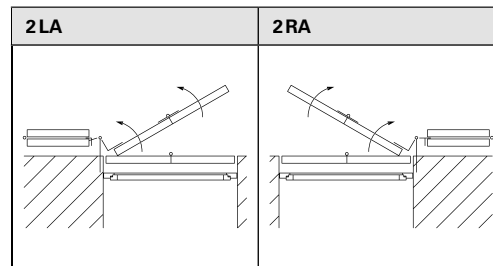
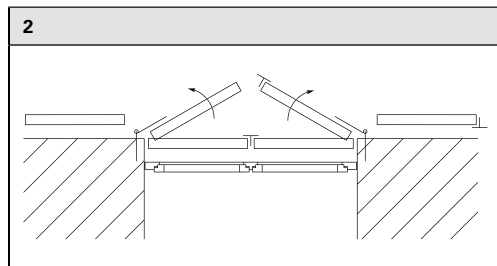
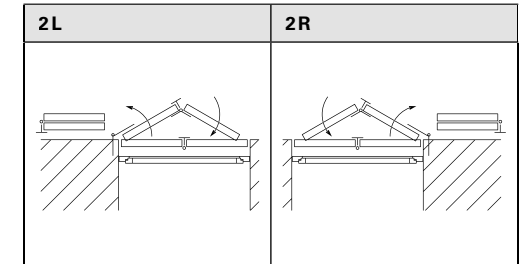
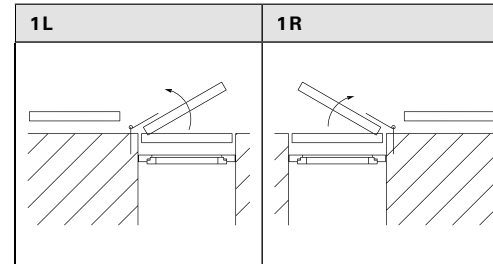

Achtung: Flügel asymmetrisch!

# Maßanleitung

► Maßaufnahme mit Lichte Breite/Höhe und Anschlagsschema

## Lichte Höhe

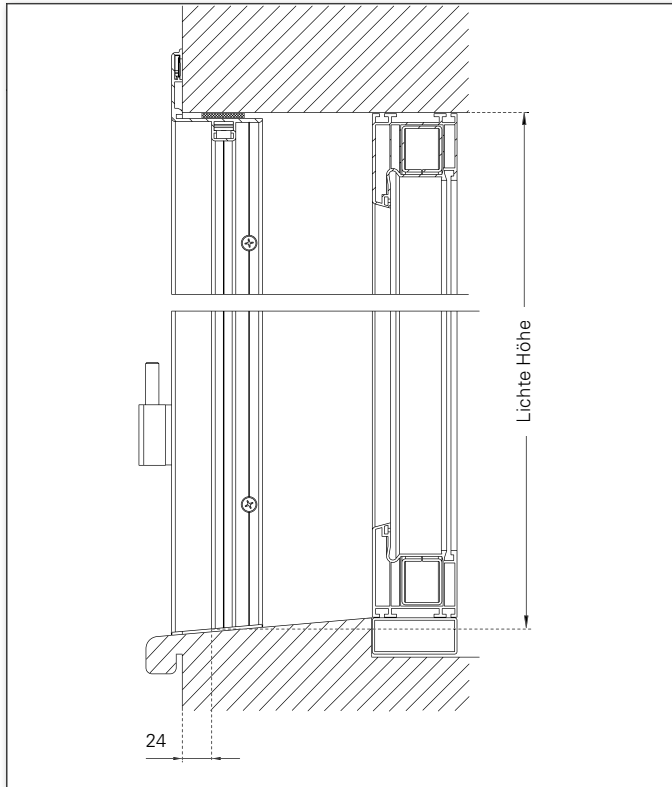

- Fensterbankschräge muß ggf. bauseits angepasst werden!

### Abzugsmaße (von EHRET)

- Lichte Breite: -10 mm
- Lichte Höhe 3-seitig: -5 mm
- Lichte Höhe 4-seitig: -8 mm

Die angegebenen Abzugsmaße werden von uns standardmäßig berücksichtigt.

## Lichte Breite

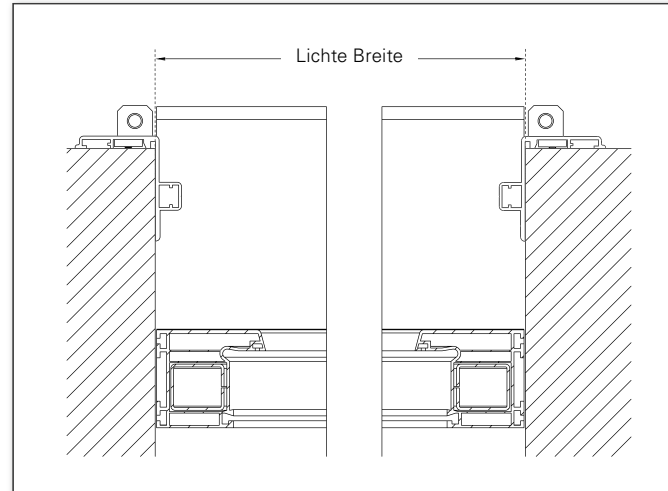

## Option Zargenverlängerung (1-120 mm)

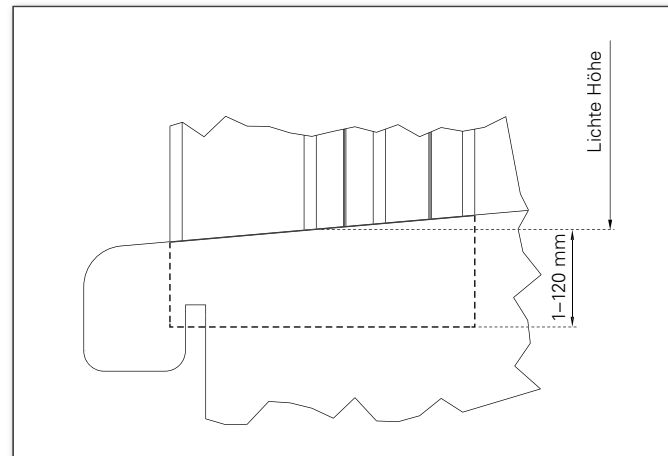

## Zargenmaße

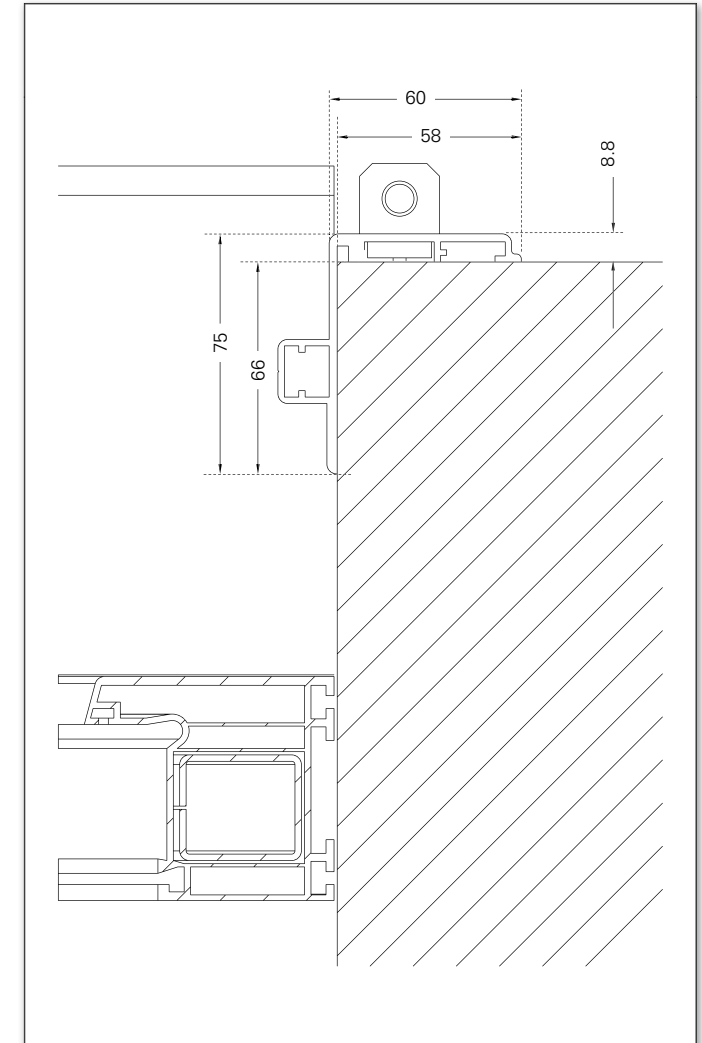

# Vormontagepakete

Paket 1 deutsch

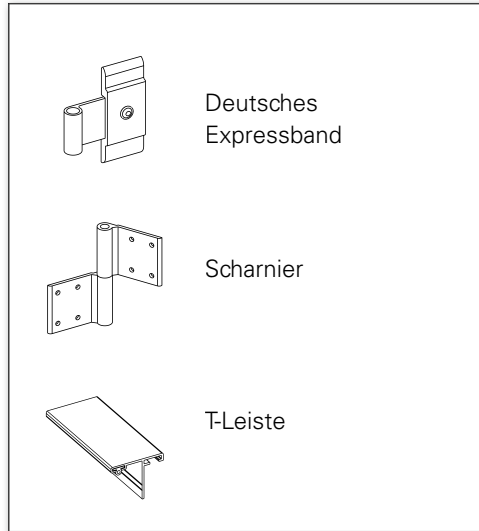

Paket 2 französisch

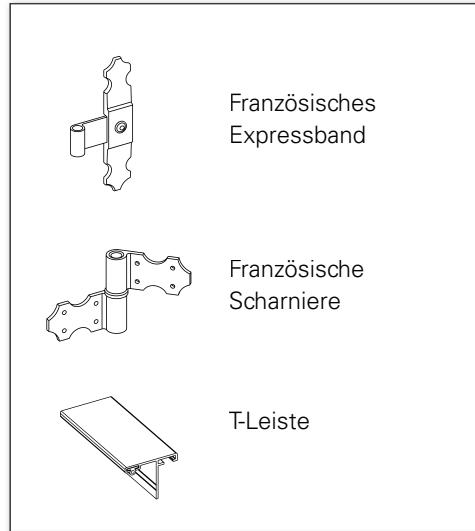



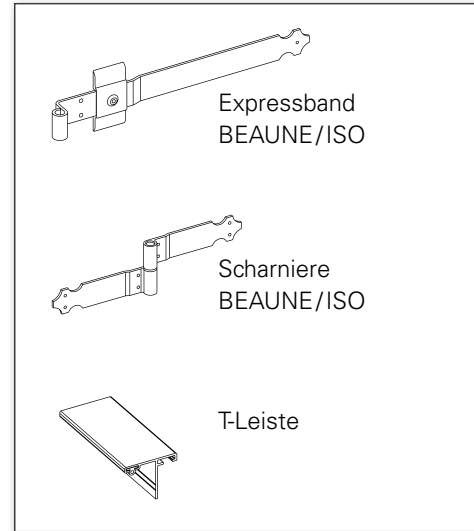



Paket 3 BEAUNE/ISO

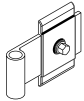
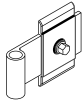
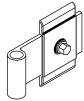
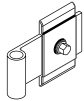
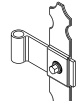
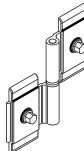
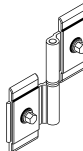
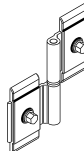
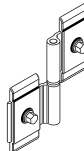
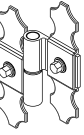
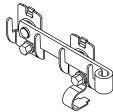
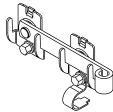
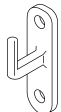
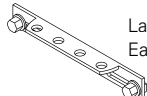
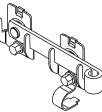
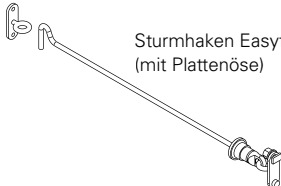
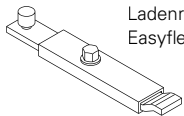
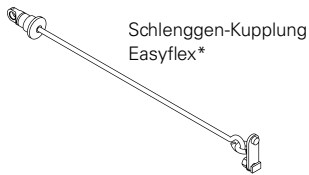
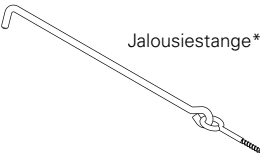
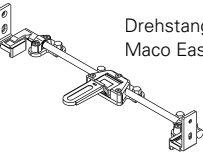

# Beschlagspakete | Easyflex | mit/ohne Vormontage

## Modelle Easyflex

Easyflex D1	Easyflex D2	Easyflex CH1	Easyflex CH2	Easyflex F
 <p>Band Easyflex</p>	 <p>Band Easyflex</p>	 <p>Band Easyflex</p>	 <p>Band Easyflex</p>	 <p>Band Easyflex F</p>
 <p>Scharnier Easyflex</p>	 <p>Scharnier Easyflex</p>	 <p>Scharnier Easyflex</p>	 <p>Scharnier Easyflex</p>	 <p>Scharnier Easyflex F</p>
 <p>Ladenverschluss Easyflex *</p>	 <p>Ladenverschluss Easyflex*</p>	 <p>Winkel- oder Gestellkloben*</p>	 <p>Ladenrechen Easyflex*</p>	 <p>Ladenverschluss Easyflex*</p>
 <p>Sturmhaken Easyflex* (mit Plattenöse)</p>	 <p>Ladenriegel Easyflex*</p>	 <p>Schlinggen-Kupplung Easyflex*</p>	 <p>Jalousiestange*</p>	 <p>Drehstangenverschluß Maco Easyflex*</p>
 <p>+ T-Leiste + Reduktionshülsen</p>	 <p>+ T-Leiste + Reduktionshülsen</p>	 <p>+ T-Leiste + Reduktionshülsen</p>	 <p>+ T-Leiste + Reduktionshülsen</p>	 <p>+ T-Leiste + Zuziehgriff* + Verriegelungswinkel*</p>

\*nicht im Vormontagepaket enthalten bei Option VOLETRONIC!

# Optionen | Vormontage | Aufbauschloss

Rahmen R75

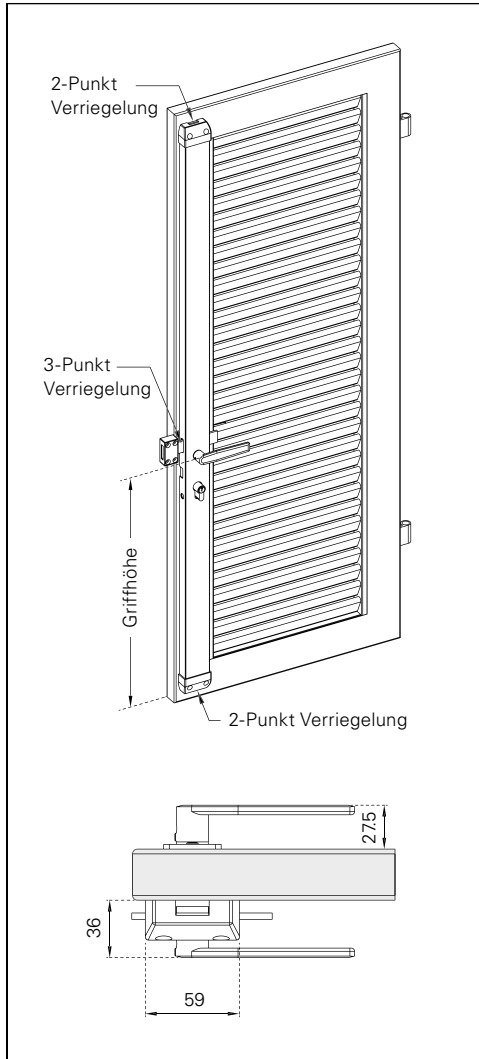

BEAUNE/ISO

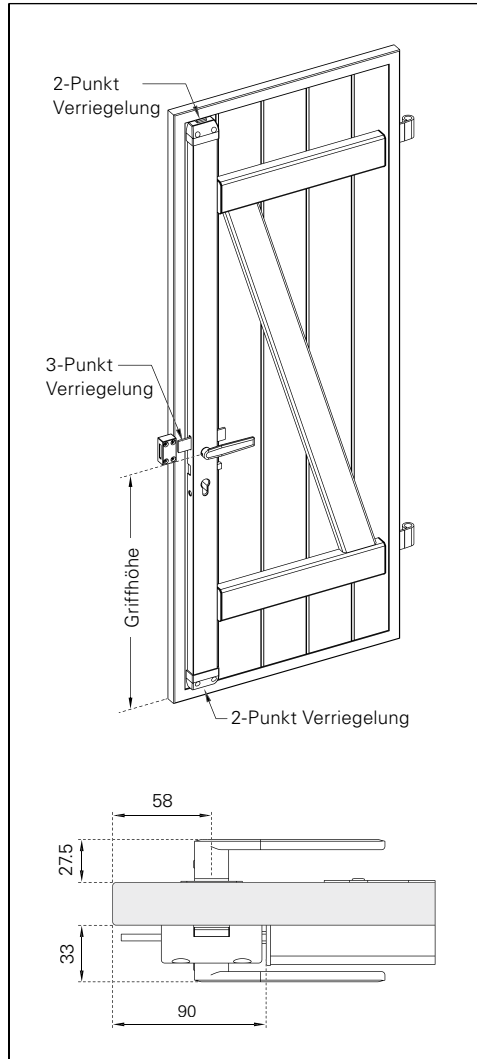

Montageart 3 im Falz

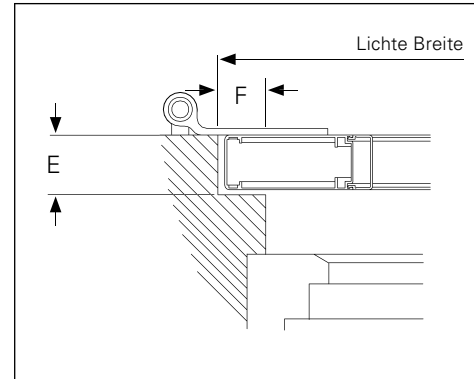

• nur mit Schema 2, 3L/3R, 3LA/3RA, 4

# Bestellformular | Schnellzarge Z75

Datum	Seite	von	Kommission
Ihre Adresse und Unterschrift			Klappladenmodell
Ihre Kundennummer			Ocean Line plus <input type="checkbox"/> ja
Ihr Sachbearbeiter			Vormontage <input type="checkbox"/> ja
gewünschter Termin			Easyflex® <input type="checkbox"/> ja
Aufteilung bei Kombimodellen			

	<input type="checkbox"/> ANGEBOT	<input type="checkbox"/> AUFTRAG	
	<i>Oberfläche</i>	<i>Farbsystem</i>	<i>Farbnummer</i>
Zarge	<input type="checkbox"/> FSM <input type="checkbox"/> Dekor <input type="checkbox"/> Divers	<input type="checkbox"/> RAL <input type="checkbox"/> NCS <input type="checkbox"/> VSR	
Zargenkloben	<input type="checkbox"/> Farbe wie Beschläge		
Flügel	<input type="checkbox"/> FSM <input type="checkbox"/> Holzdekor <input type="checkbox"/> Divers	<input type="checkbox"/> RAL <input type="checkbox"/> NCS <input type="checkbox"/> VSR	
Beschläge	<input type="checkbox"/> FSM EHRET	<input type="checkbox"/> RAL <input type="checkbox"/> NCS <input type="checkbox"/> VSR	



Tel. +49 (0) 78 22/439-0  
 Fax +49 (0) 78 22/439-217  
 www.ehret.com

**Nachbestellung**  
 bei Nachlieferungen unbedingt  
 ursprüngliche Auftrags-Nr. angeben:

--

▶ Beschläge bitte auf der Extra-Seite eintragen!

Pos.	Anzahl Elemente	Anschlag-schemata	Lichte Maße			Optionen <small>mit Aufpreis</small>		Vormontage Aufbaus Schloss					Sonstiges
			Lichte Breite <i>in mm</i>	Lichte Höhe <i>in mm</i>	höchste Höhe <i>bei Rundbögen</i>	Zargenverlängerung <i>1-120 mm</i>	Zarge <i>4-seitig</i>	2-Punkt- Verriegelung	3-Punkt- Verriegelung	Griff außen	mit Profizylinder	Griffhöhe	
						<input type="checkbox"/> ____ mm	<input type="checkbox"/>	<input type="checkbox"/>	<input type="checkbox"/>	<input type="checkbox"/>	<input type="checkbox"/>		
						<input type="checkbox"/> ____ mm	<input type="checkbox"/>	<input type="checkbox"/>	<input type="checkbox"/>	<input type="checkbox"/>	<input type="checkbox"/>		
						<input type="checkbox"/> ____ mm	<input type="checkbox"/>	<input type="checkbox"/>	<input type="checkbox"/>	<input type="checkbox"/>	<input type="checkbox"/>		
						<input type="checkbox"/> ____ mm	<input type="checkbox"/>	<input type="checkbox"/>	<input type="checkbox"/>	<input type="checkbox"/>	<input type="checkbox"/>		
						<input type="checkbox"/> ____ mm	<input type="checkbox"/>	<input type="checkbox"/>	<input type="checkbox"/>	<input type="checkbox"/>	<input type="checkbox"/>		
						<input type="checkbox"/> ____ mm	<input type="checkbox"/>	<input type="checkbox"/>	<input type="checkbox"/>	<input type="checkbox"/>	<input type="checkbox"/>		
						<input type="checkbox"/> ____ mm	<input type="checkbox"/>	<input type="checkbox"/>	<input type="checkbox"/>	<input type="checkbox"/>	<input type="checkbox"/>		
						<input type="checkbox"/> ____ mm	<input type="checkbox"/>	<input type="checkbox"/>	<input type="checkbox"/>	<input type="checkbox"/>	<input type="checkbox"/>		
						<input type="checkbox"/> ____ mm	<input type="checkbox"/>	<input type="checkbox"/>	<input type="checkbox"/>	<input type="checkbox"/>	<input type="checkbox"/>		
						<input type="checkbox"/> ____ mm	<input type="checkbox"/>	<input type="checkbox"/>	<input type="checkbox"/>	<input type="checkbox"/>	<input type="checkbox"/>		

## Bestellformular | Schnellzarge Z75 | Beschlage

Datum \_\_\_\_\_ Seite \_\_\_\_\_ von \_\_\_\_\_ Kommission \_\_\_\_\_ Ihre Kundennummer \_\_\_\_\_

### mit Vormontage

- Paket 1 – deutsches Expressband
- Paket 2 – franzsisches Expressband
- Paket 3 – Expressband ISO
- Paket Easyflex D1  Paket Easyflex D2
- Paket Easyflex CH1  Paket Easyflex CH2
- Paket Easyflex F

### ohne Vormontage

- Kreuzband – deutsch  Kreuzband – franzsisch
- ISO Langband
- Easyflex-Band D  Easyflex-Band CH
- Easyflex-Band F
- Paket Easyflex D1  Paket Easyflex D2
- Paket Easyflex CH1  Paket Easyflex CH2
- Paket Easyflex F

- Ladenverschluss & Ladenriegel
- Drehstangenverschluss
- Rechen & Sperrstange
- Schhenggen & Winkelkloben
- Ladenhalter Standard M10
- Ladenhalter Frauenkopf M10
- Vorreiber M10
- Zugwindfalle\*
- Windfalle\*

\* nicht mglich bei Easyflex

## Zusatzinformationen | Schnellzarge Z75

Pos.	Zusatzinformation



**EHRET GmbH**

Bahnhofstrasse 14-18

D-77972 Mahlberg

Tel. +49(0) 78 22/439-0

Fax +49(0) 78 22/439-116

[www.ehret.com](http://www.ehret.com)

Made in Germany

© 06.2021 EHRET GmbH | F12.D | Technische Änderungen vorbehalten