

Fast frame Z75

Installation frames / Frames



Order form and
planning tool

Stop diagrams

Each view is from the inside!

Deduction clearances are taken into consideration as standard.

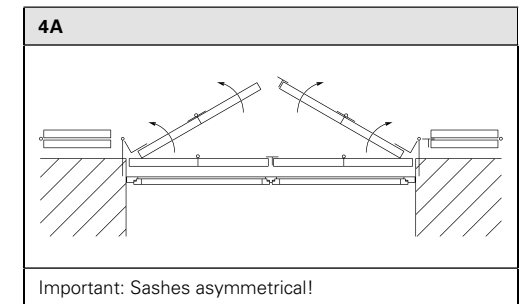
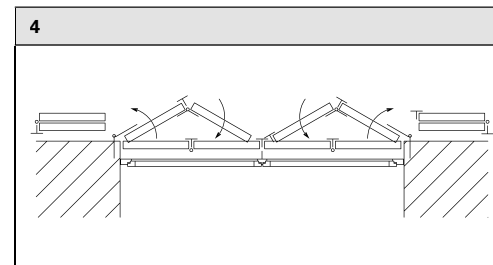
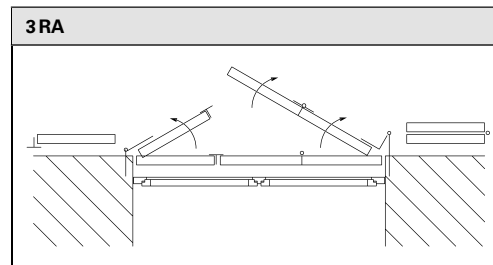
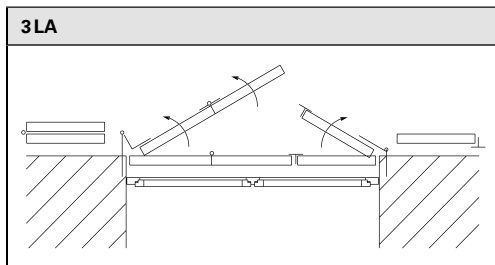
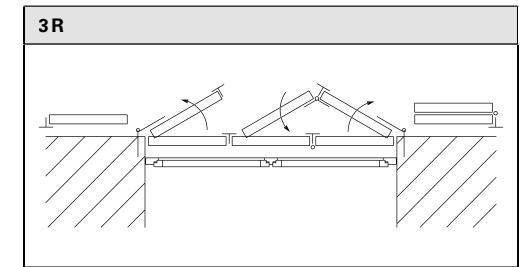
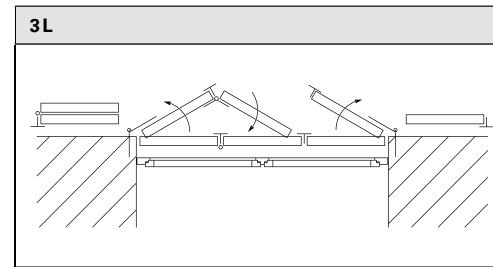
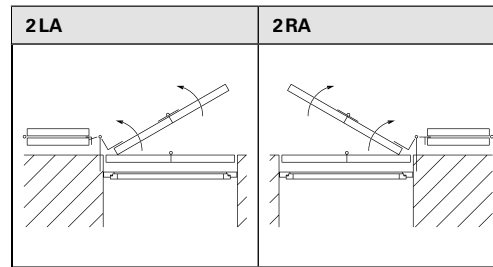
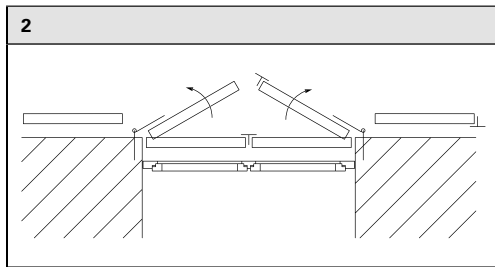
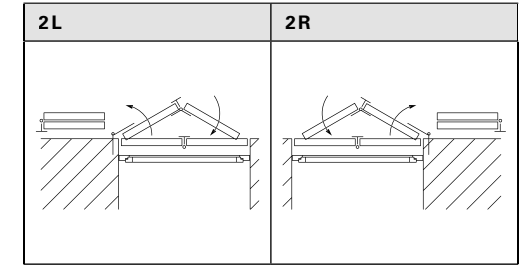
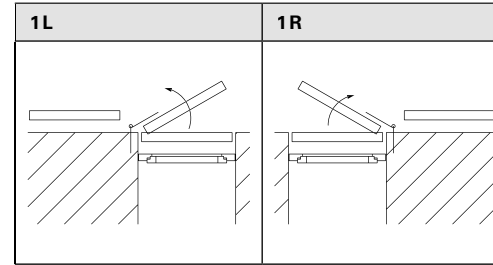

Measuring instructions

► Measurements taken with clear width / height and stop diagram

Clear height

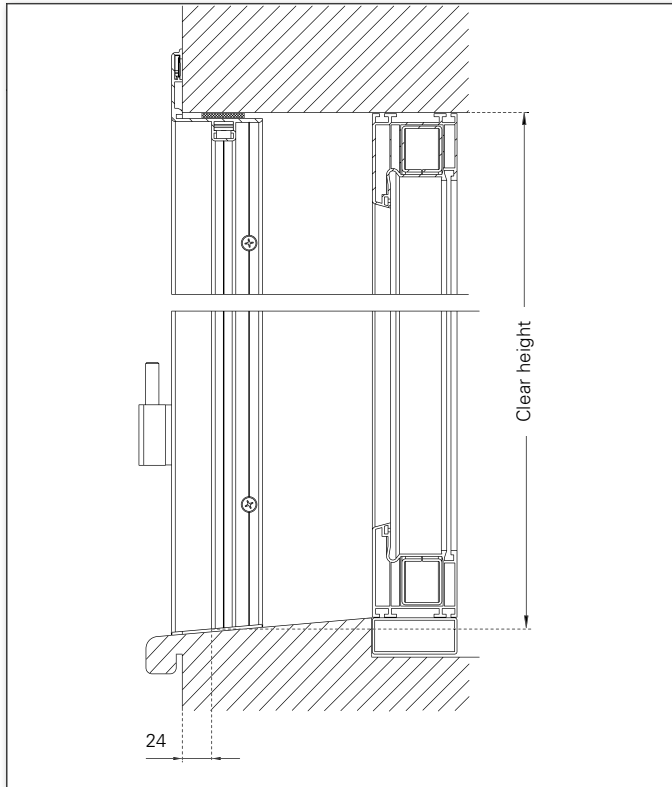

- Window sill angle may need to be adjusted on site.

Deduction clearances (from EHRET)

- Clear width: -10mm
- Clear height 3-sided: -5mm
- Clear height 4-sided: -8mm

The specified deduction clearances are taken into consideration as standard.

Clear width

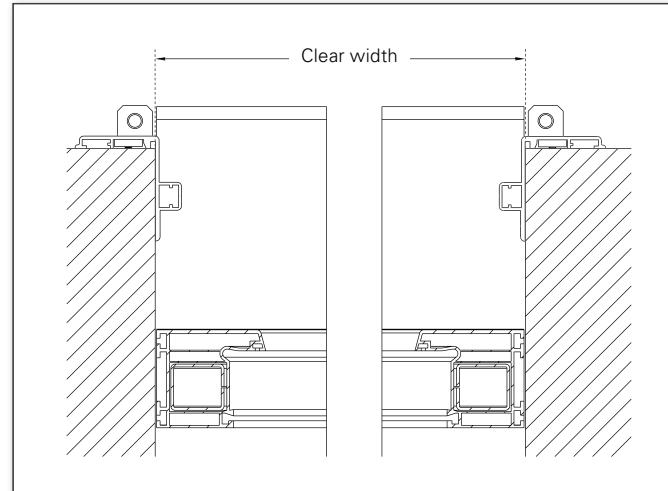

Frame extension option (1–120 mm)

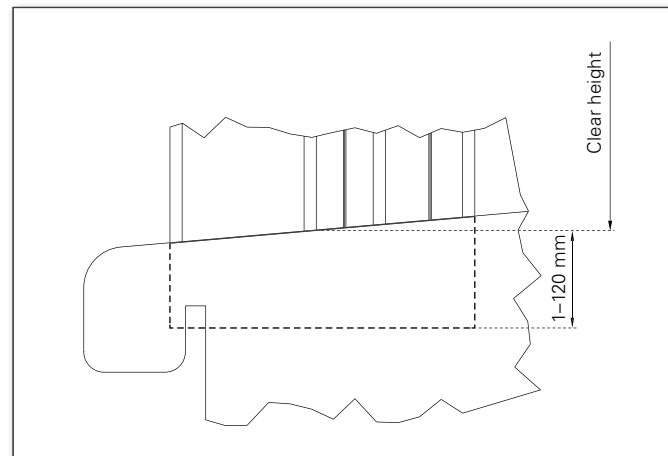

Fast frame dimensions

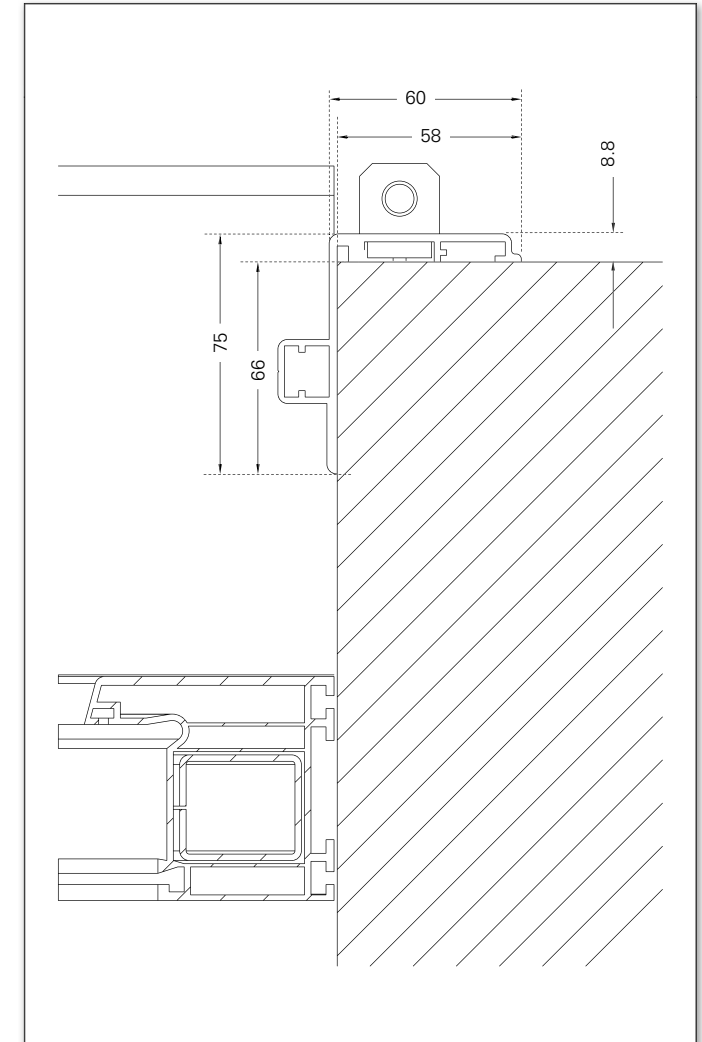

Pre-installation packages

Paket 1 german

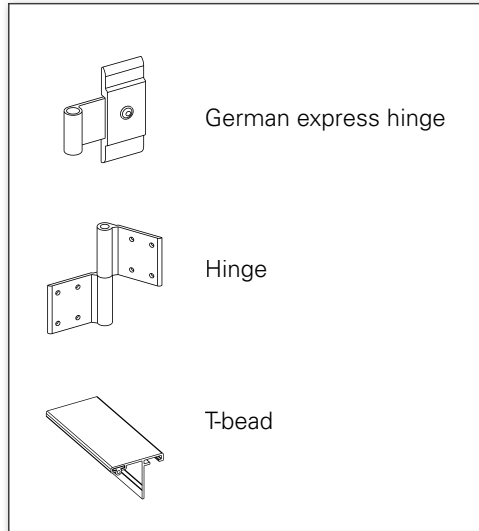

Paket 2 french

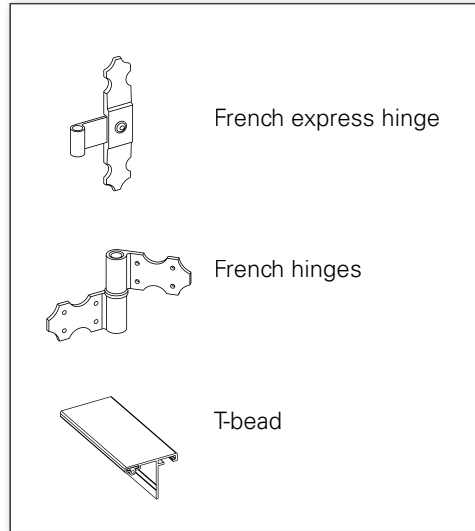



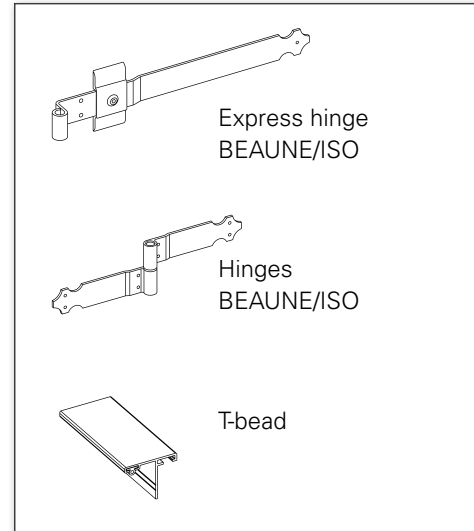





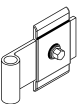
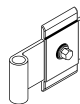
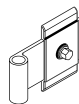
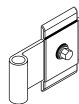
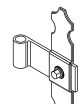
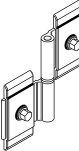
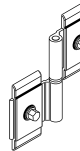
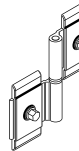
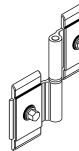
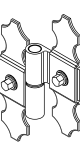
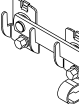
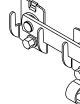
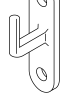
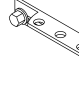
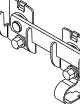

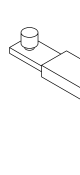
Paket 3 BEAUNE/ISO

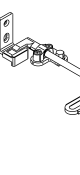

Hardware packages | Easyflex | with/without pre-installation

Easyflex model

Easyflex D1	Easyflex D2	Easyflex CH1	Easyflex CH2	Easyflex F
 <p>Easyflex hinge</p>	 <p>Easyflex hinge</p>	 <p>Easyflex hinge</p>	 <p>Easyflex hinge</p>	 <p>Easyflex F hinge</p>
 <p>Easyflex butterfly hinge</p>	 <p>Easyflex butterfly hinge</p>	 <p>Easyflex butterfly hinge</p>	 <p>Easyflex butterfly hinge</p>	 <p>Easyflex F butterfly hinge</p>
 <p>Easyflex shutter closure*</p>	 <p>Easyflex shutter closure*</p>	 <p>Angle bracket or frame bracket*</p>	 <p>Easyflex shutter rod*</p>	 <p>Easyflex shutter closure*</p>
 <p>Easyflex storm hook* (with plate eye)</p>	 <p>Easyflex shutter lock*</p>	 <p>Easyflex hook coupling*</p>	 <p>Blind rod*</p>	 <p>Easyflex Maco rotating rod closure*</p>
 <p>+ T-bead + Reduction sleeves</p>	 <p>+ T-bead + Reduction sleeves</p>	 <p>+ T-bead + Reduction sleeves</p>	 <p>+ T-bead + Reduction sleeves</p>	 <p>+ T-bead + Pull handle* + Locking bracket*</p>

*Not included in pre-installation package for VOLETRONIC 230 V option

Options | Pre-installation | Add-on lock

R75 frame

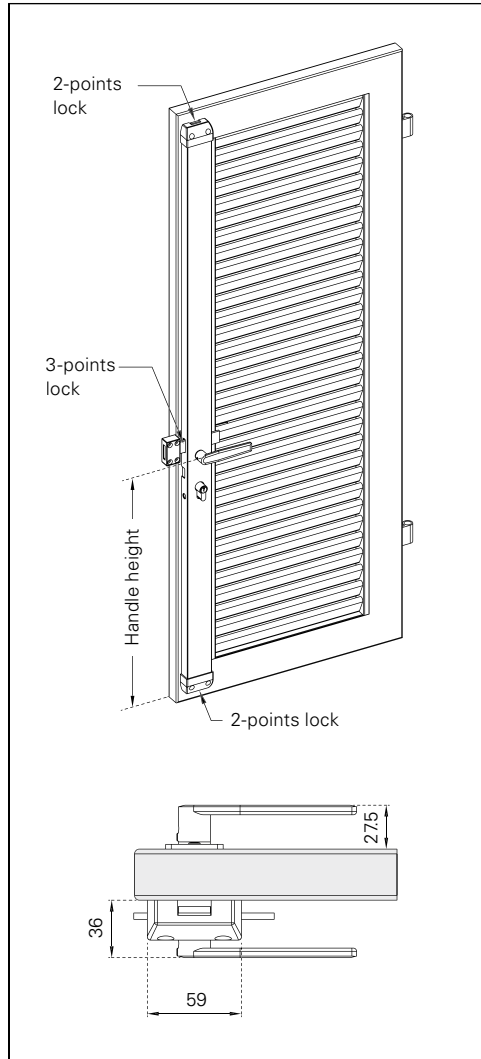

BEAUNE/ISO

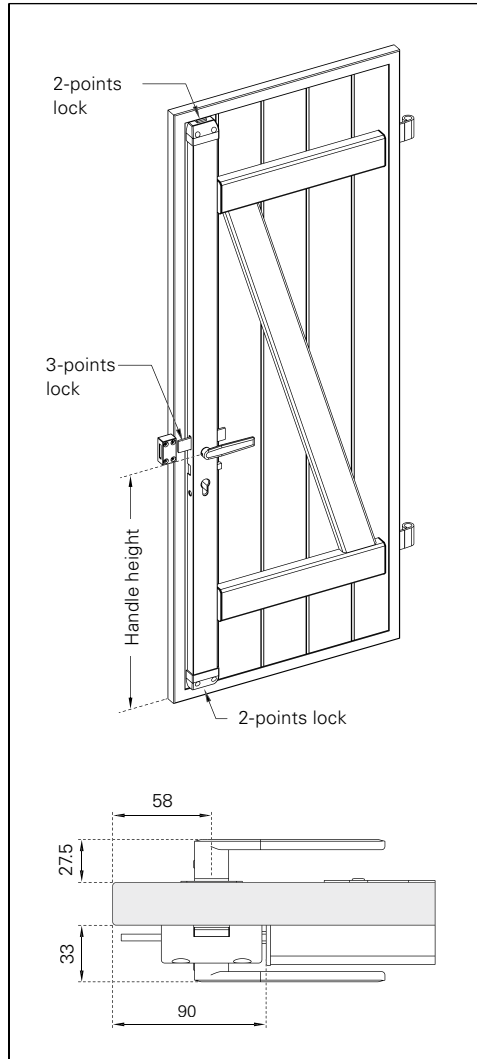

Installation type 3 in rabbet

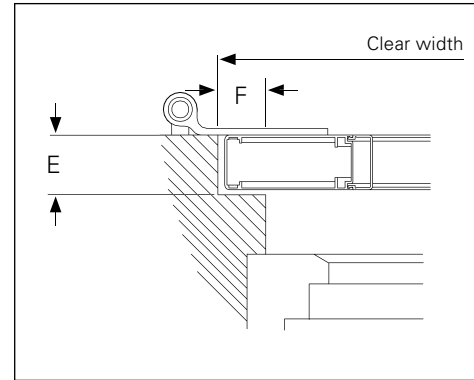

• only with diagram 2, 3L/3R, 3LA/3RA, 4

Order form | Fast frame Z75

Date _____ Page _____ of _____
 Your address and signature _____

Consignment _____
 Window shutter model _____

Split with combi models _____

Your customer number _____
 Your processor _____
 Preferred delivery date _____

Ocean Line plus yes
 Pre-installation yes
 Easyflex® yes

	<input type="checkbox"/> OFFER	<input type="checkbox"/> ORDER
	Surface	Colour system
	Colour no.	
Frame	<input type="checkbox"/> FSM	<input type="checkbox"/> RAL
	<input type="checkbox"/> Finish	<input type="checkbox"/> NCS
	<input type="checkbox"/> Various	<input type="checkbox"/> VSR
Frame brackets	<input type="checkbox"/> Fittings colour	
Sash	<input type="checkbox"/> FSM	<input type="checkbox"/> RAL
	<input type="checkbox"/> Wood finish	<input type="checkbox"/> NCS
	<input type="checkbox"/> Various	<input type="checkbox"/> VSR
Fittings	<input type="checkbox"/> FSM	<input type="checkbox"/> RAL
EHRET	<input type="checkbox"/> Various	<input type="checkbox"/> NCS
		<input type="checkbox"/> VSR



Tel. +49 (0) 78 22/439-0
 Fax +49 (0) 78 22/439-217
 www.ehret.com

Follow-up order
 The original order no. must be specified
 in the event of follow-up deliveries:

▶ Please enter the fittings on the extra page.

Item	Quantity Elements	Stop diagram	Clear dimensions			Options with surcharge		Pre-installation Add-on lock					Miscellaneous
			Clear width in mm	Clear height in mm	Highest height for round arches	Frame extension 1-120 mm	Frame, 4-sided	2-points lock	3-points lock	Handle on the outside with profile cylinder	Handle height		
						<input type="checkbox"/> ____ mm	<input type="checkbox"/>	<input type="checkbox"/>	<input type="checkbox"/>	<input type="checkbox"/>	<input type="checkbox"/>		
						<input type="checkbox"/> ____ mm	<input type="checkbox"/>	<input type="checkbox"/>	<input type="checkbox"/>	<input type="checkbox"/>	<input type="checkbox"/>		
						<input type="checkbox"/> ____ mm	<input type="checkbox"/>	<input type="checkbox"/>	<input type="checkbox"/>	<input type="checkbox"/>	<input type="checkbox"/>		
						<input type="checkbox"/> ____ mm	<input type="checkbox"/>	<input type="checkbox"/>	<input type="checkbox"/>	<input type="checkbox"/>	<input type="checkbox"/>		
						<input type="checkbox"/> ____ mm	<input type="checkbox"/>	<input type="checkbox"/>	<input type="checkbox"/>	<input type="checkbox"/>	<input type="checkbox"/>		
						<input type="checkbox"/> ____ mm	<input type="checkbox"/>	<input type="checkbox"/>	<input type="checkbox"/>	<input type="checkbox"/>	<input type="checkbox"/>		
						<input type="checkbox"/> ____ mm	<input type="checkbox"/>	<input type="checkbox"/>	<input type="checkbox"/>	<input type="checkbox"/>	<input type="checkbox"/>		
						<input type="checkbox"/> ____ mm	<input type="checkbox"/>	<input type="checkbox"/>	<input type="checkbox"/>	<input type="checkbox"/>	<input type="checkbox"/>		
						<input type="checkbox"/> ____ mm	<input type="checkbox"/>	<input type="checkbox"/>	<input type="checkbox"/>	<input type="checkbox"/>	<input type="checkbox"/>		

Order form | **Fast frame Z75** | Fittings

Date
Page
of
Consignment
Your customer number

With pre-installation

- Package 1 – German express hinge
- Package 2 – French express hinge
- Package 3 – ISO express hinge
- Easyflex package D1 Easyflex package D2
- Easyflex package CH1 Easyflex package CH2
- Package Easyflex F

Without pre-installation

- Cross hinge – German
- Cross hinge – French
- ISO long hinge
- Easyflex hinge D Easyflex hinge CH
- Easyflex hinge F
- Easyflex package D1 Easyflex package D2
- Easyflex package CH1 Easyflex package CH2
- Package Easyflex F

- Shutter closure & shutter lock
- Espagnolette
- Rod & lock bar
- Hook & angle bracket
- Shutter holder, standard M10
- Shutter holder, lady head M10
- Sash lock M10
- Pull catch*
- Catch*

* not possible with Easyflex®

Additional information | **Fast frame Z75**

Item	Additional information

EHRET GmbH

Bahnhofstrasse 14-18

D-77972 Mahlberg

Tel. +49(0) 78 22/439-0

Fax +49(0) 78 22/439-116

www.ehret.com

Made in Germany

© 06.2021 EHRET GmbH | F12.E | Subject to technical modifications