

## Intelaiatura rapida Z75

Telai di montaggio / intelaiature



Moduli di ordinazione  
e scheda tecnica

# Schemi di posa

Le viste sono dall'interno!

Consideriamo le quote di deduzione (distanza tra larghezza libera e larghezza persiana a battente) quote standard.

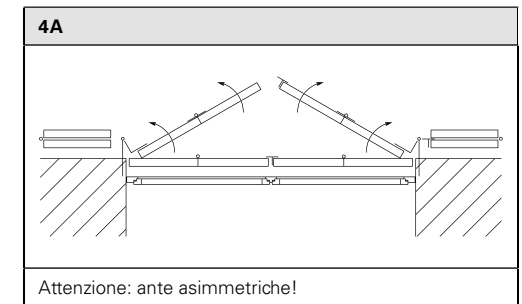
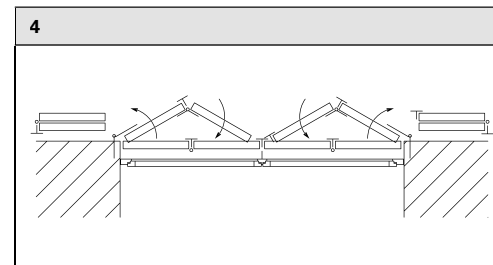
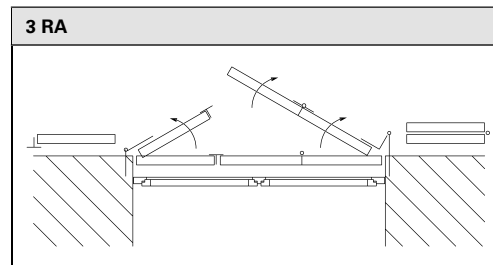
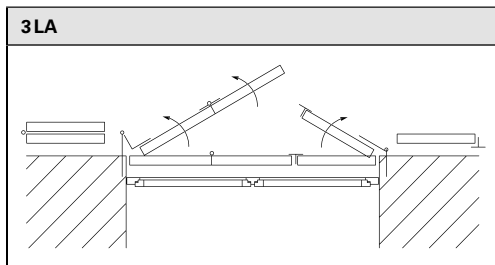
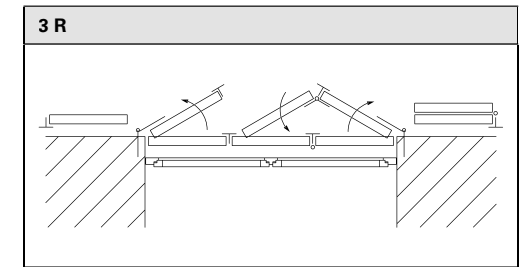
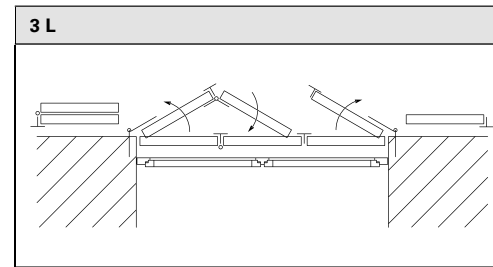
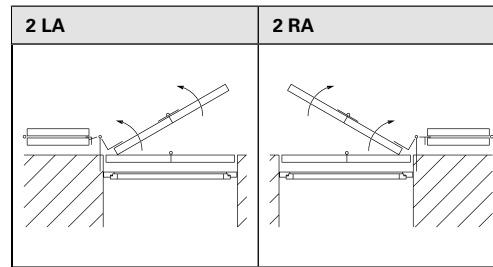
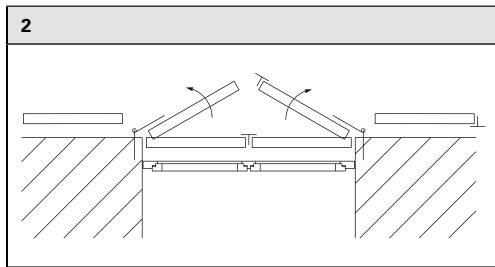
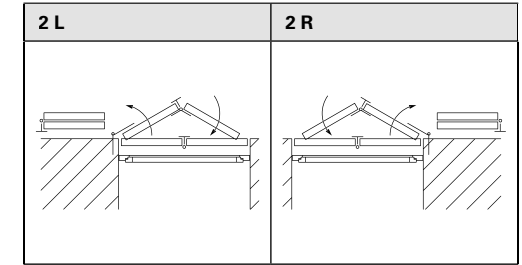
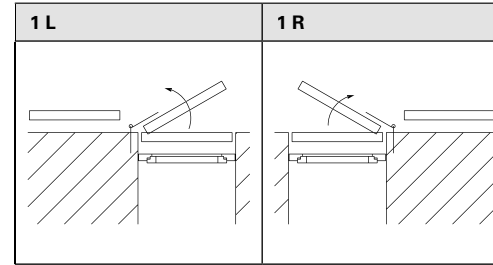

# Istruzioni di misurazione

► Rilevamento della misura con larghezza/altezza libera e schema di posa

## Altezza libera

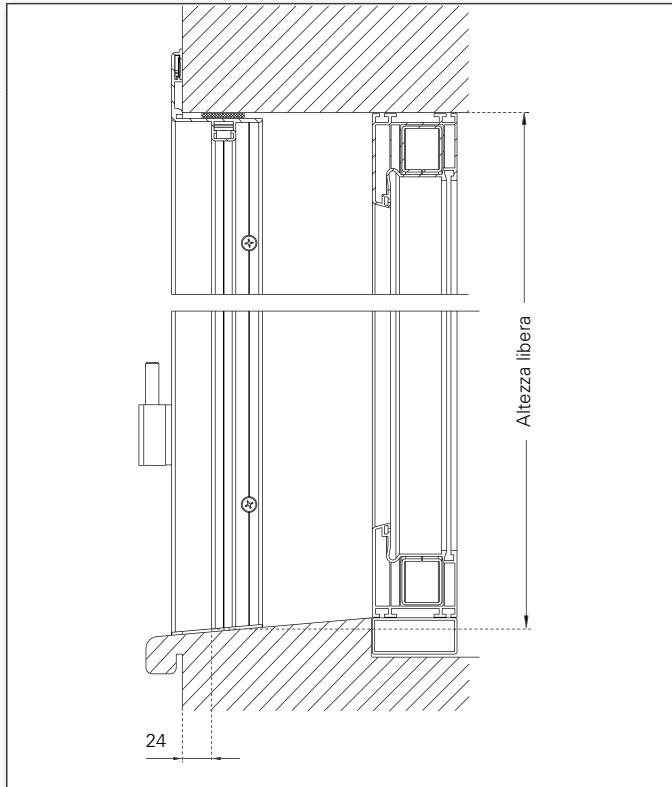

- L'inclinazione del davanzale interno deve eventualmente essere adattata dal cliente!

### Quote di deduzione (di EHRET)

- Larghezza libera: -10mm
- Altezza libera 3 lati: -5mm
- Altezza libera 4 lati: -8mm

Le quote di deduzione (distanza tra larghezza libera e larghezza persiana a battente) indicate sono considerate standard.

## Larghezza libera

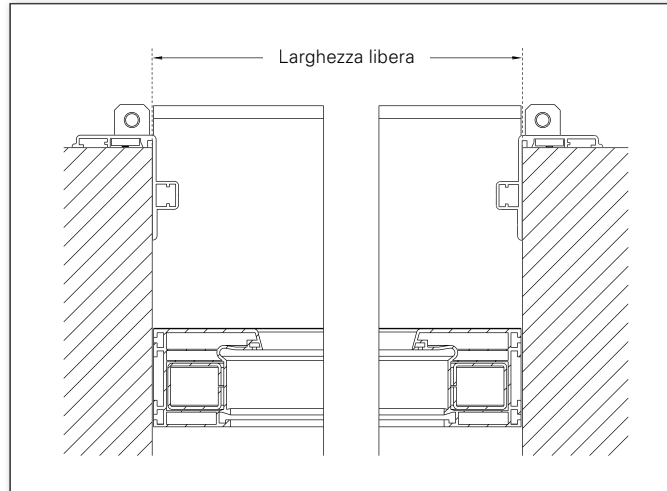

## Opzione prolunga intelaiatura (1-120 mm)

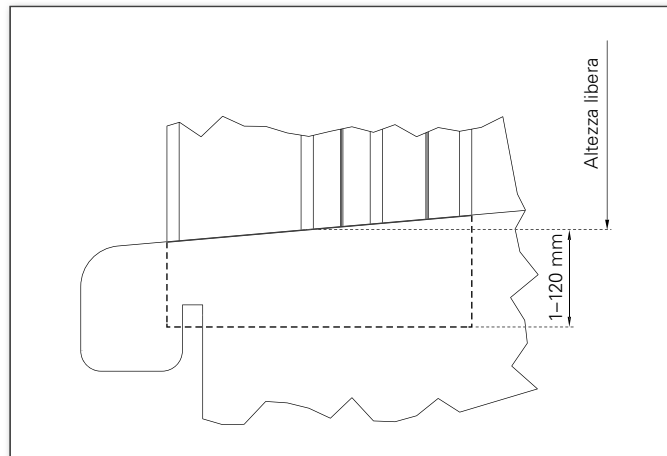

## Dimensioni del intelaiatura

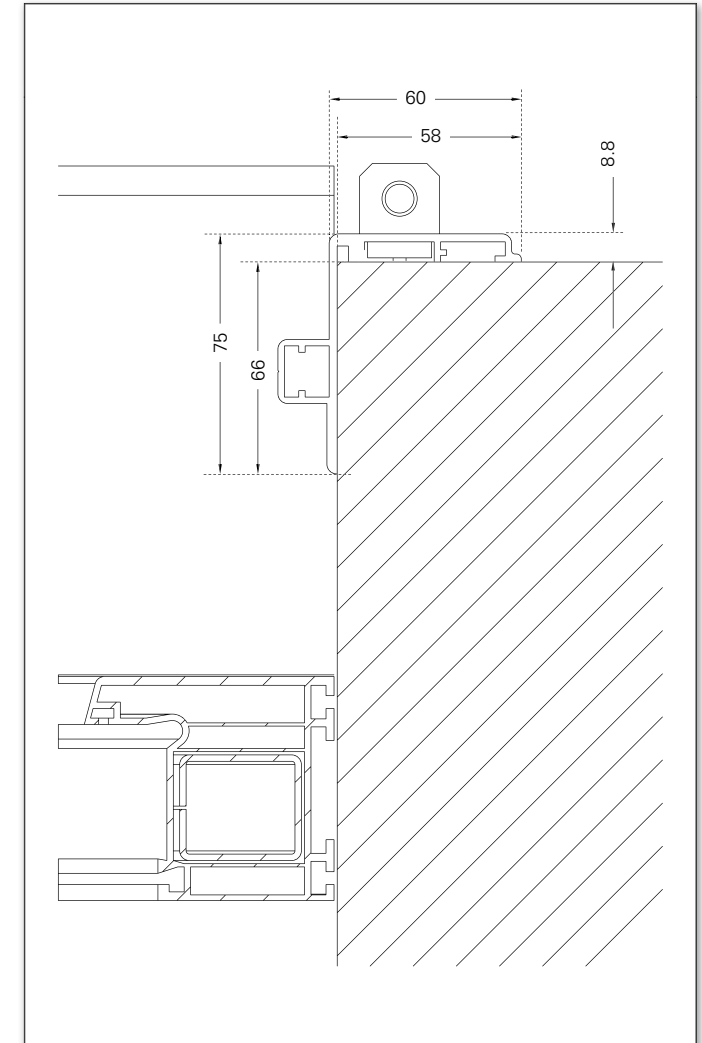

# Set di premontaggio

Set 1 tedesca

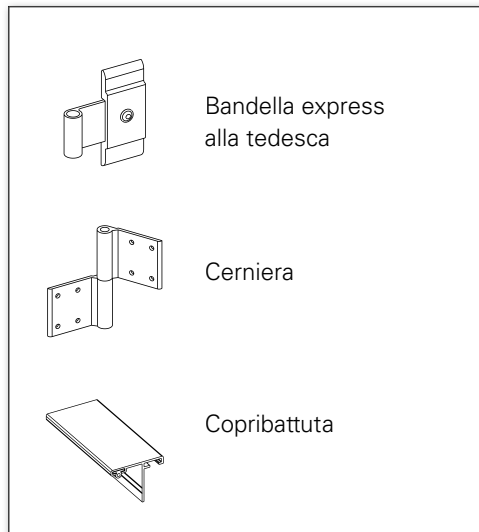

Paket 2 francese

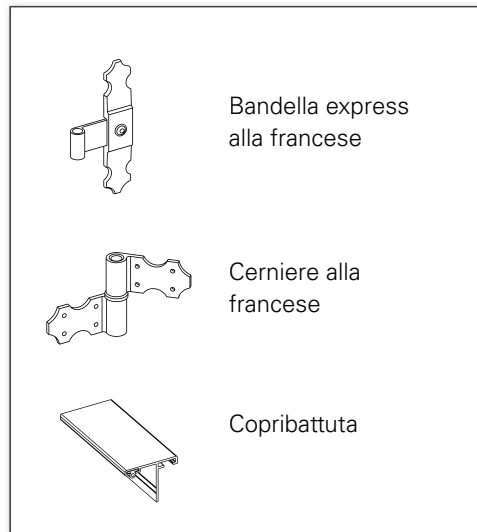

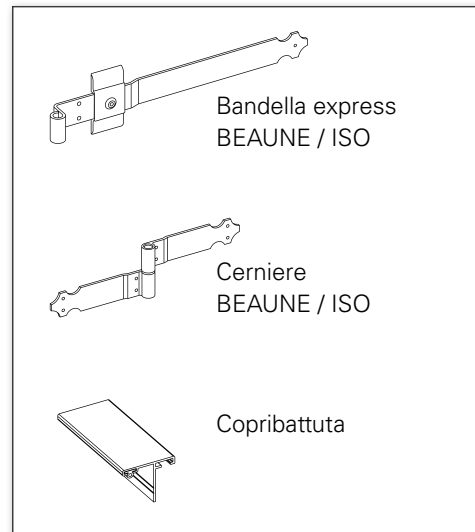

Paket 3 BEAUNE/ISO

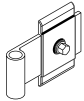
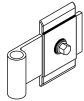
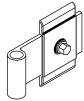
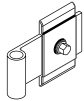
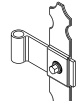
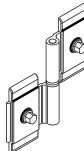
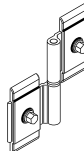
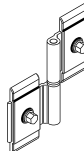
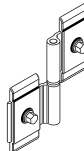
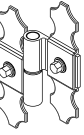
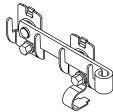
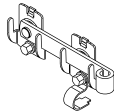
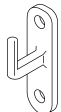
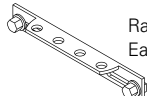
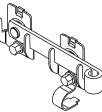

# Pacchetti ferramenta | Easyflex | con/senza montaggio preliminare

## Modelli Easyflex

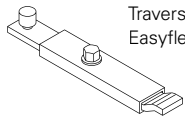
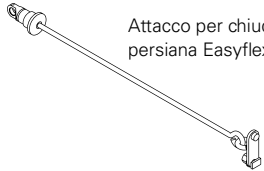
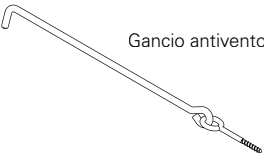
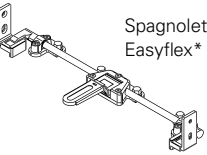
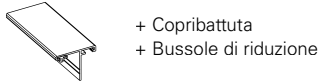
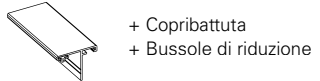
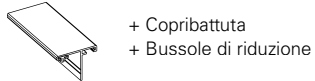
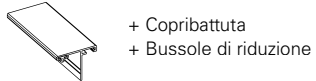
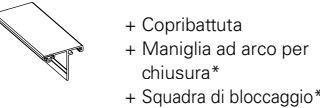
Easyflex D1	Easyflex D2	Easyflex CH1	Easyflex CH2	Easyflex F
 Bandella Easyflex	 Bandella Easyflex	 Bandella Easyflex	 Bandella Easyflex	 Bandella Easyflex F
 Cerniera Easyflex	 Cerniera Easyflex	 Cerniera Easyflex	 Cerniera Easyflex	 Cerniera Easyflex F
 Chiusura persiana Easyflex*	 Chiusura persiana Easyflex*	 Archetto angolare o di chiusura*	 Rastrelliera persiana Easyflex*	 Chiusura persiana Easyflex*
 Gancio antivento Easyflex* (con occhiello piastra)	 Traversa persiana Easyflex*	 Attacco per chiudi-persiana Easyflex*	 Gancio antivento*	 Spagnoletta Maco Easyflex*
 + Copribattuta + Bussole di riduzione	 + Copribattuta + Bussole di riduzione	 + Copribattuta + Bussole di riduzione	 + Copribattuta + Bussole di riduzione	 + Copribattuta + Maniglia ad arco per chiusura* + Squadra di bloccaggio*

\*non contenuti nel pacchetto di montaggio preliminare con l'opzione VOLETRONIC!

# Opzioni | Montaggio preliminare | Serratura sovrapposta

Telaio R75

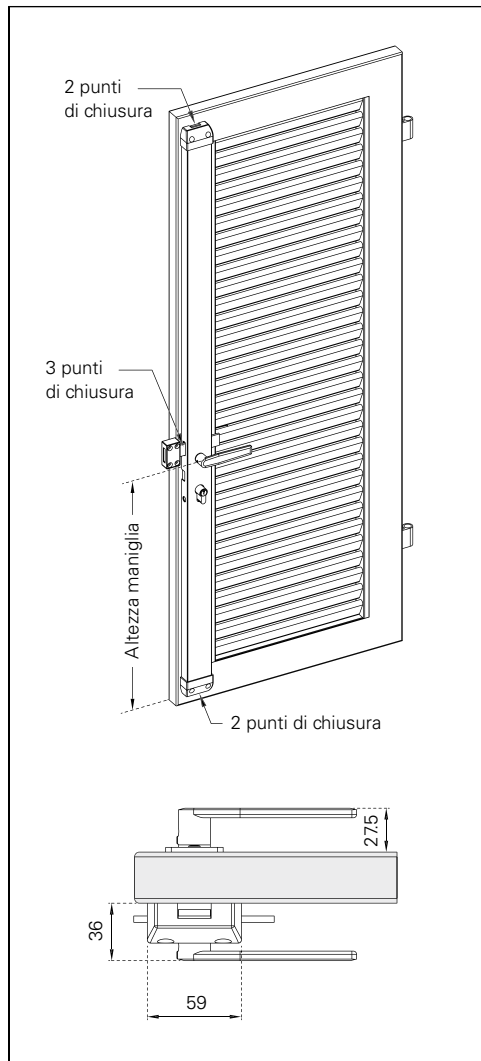

BEAUNE/ISO

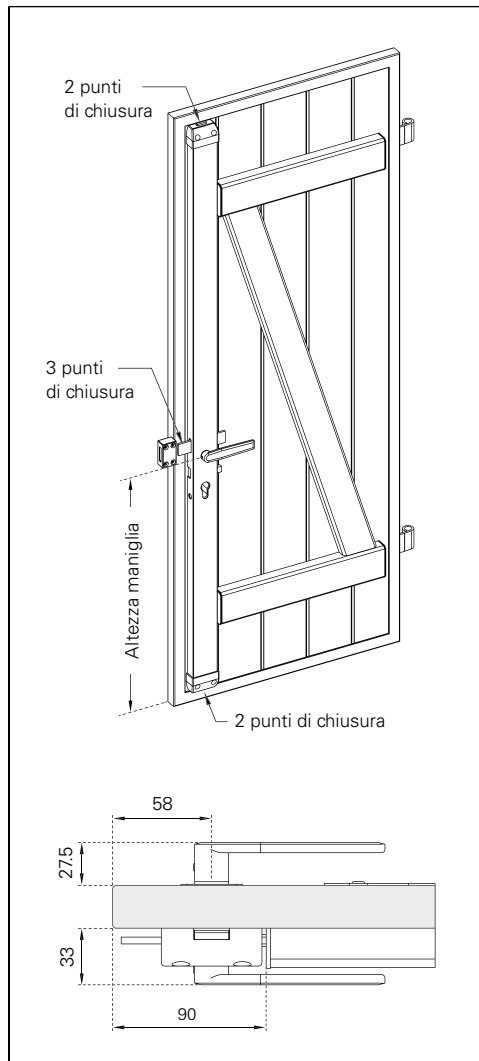

Tipo di montaggio 3 nella battentatura

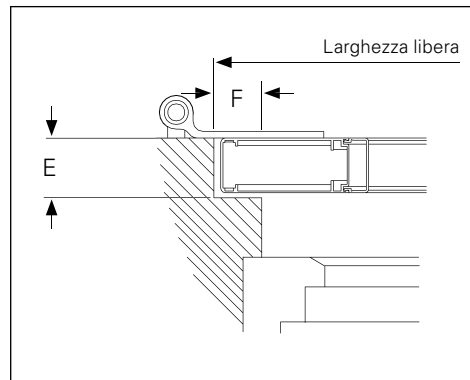

- solo con schemi 2, 3L/3R, 3LA/3RA, 4

# Modulo d'ordine | Intelaiatura rapida Z75

Data _____ pagina _____ di _____	Commissione _____
Indirizzo e firma _____	Modello di persiana a battenti _____
_____	_____
_____	Suddivisione per modelli combinati _____
_____	_____
Codice cliente _____	Ocean Line plus <input type="checkbox"/> sì
Addetto _____	Montaggio preliminare <input type="checkbox"/> sì
Termine di consegna desiderato _____	Easyflex® <input type="checkbox"/> sì

	<input type="checkbox"/> OFFERTA	<input type="checkbox"/> ORDINE	
	Superficie	Sistema colori	Codice
Intelaiatura	<input type="checkbox"/> FSM*	<input type="checkbox"/> RAL	
	<input type="checkbox"/> Decorazione	<input type="checkbox"/> NCS	
	<input type="checkbox"/> Varie	<input type="checkbox"/> VSR	
Ante	<input type="checkbox"/> FSM*	<input type="checkbox"/> RAL	
	<input type="checkbox"/> Decor. legno	<input type="checkbox"/> NCS	
	<input type="checkbox"/> Varie	<input type="checkbox"/> VSR	
Ferramenta	<input type="checkbox"/> FSM*	<input type="checkbox"/> RAL	
EHRET	<input type="checkbox"/> Varie	<input type="checkbox"/> NCS	
		<input type="checkbox"/> VSR	



Tel. +49 (0) 78 22/439-0  
 Fax +49 (0) 78 22/439-217  
 www.ehret.com

**Ordinazione successiva**  
*in caso di forniture successive indicare assolutamente il n. ordine originario:*

--

\*struttura fine e opaca

▶ Si prega di inserire la ferramenta nella pagina apposita

Pos.	Numero di elementi	Schema di posa	Quote libere			Opzioni con sovrapprezzo		Montaggio preliminare Serratura sovrapposta				Altezza maniglia	Varie
			Larghezza libera in mm	Altezza libera in mm	L'altezza massima con archi tondi	Prolunga intelaiatura 1-120 mm	Intelaiatura, 4 lati	2 punti di chiusura	3 punti di chiusura	maniglia esterna	con cilindro profilato Euro		
						<input type="checkbox"/> ____ mm	<input type="checkbox"/>	<input type="checkbox"/>	<input type="checkbox"/>	<input type="checkbox"/>	<input type="checkbox"/>		
						<input type="checkbox"/> ____ mm	<input type="checkbox"/>	<input type="checkbox"/>	<input type="checkbox"/>	<input type="checkbox"/>	<input type="checkbox"/>		
						<input type="checkbox"/> ____ mm	<input type="checkbox"/>	<input type="checkbox"/>	<input type="checkbox"/>	<input type="checkbox"/>	<input type="checkbox"/>		
						<input type="checkbox"/> ____ mm	<input type="checkbox"/>	<input type="checkbox"/>	<input type="checkbox"/>	<input type="checkbox"/>	<input type="checkbox"/>		
						<input type="checkbox"/> ____ mm	<input type="checkbox"/>	<input type="checkbox"/>	<input type="checkbox"/>	<input type="checkbox"/>	<input type="checkbox"/>		
						<input type="checkbox"/> ____ mm	<input type="checkbox"/>	<input type="checkbox"/>	<input type="checkbox"/>	<input type="checkbox"/>	<input type="checkbox"/>		
						<input type="checkbox"/> ____ mm	<input type="checkbox"/>	<input type="checkbox"/>	<input type="checkbox"/>	<input type="checkbox"/>	<input type="checkbox"/>		
						<input type="checkbox"/> ____ mm	<input type="checkbox"/>	<input type="checkbox"/>	<input type="checkbox"/>	<input type="checkbox"/>	<input type="checkbox"/>		
						<input type="checkbox"/> ____ mm	<input type="checkbox"/>	<input type="checkbox"/>	<input type="checkbox"/>	<input type="checkbox"/>	<input type="checkbox"/>		
						<input type="checkbox"/> ____ mm	<input type="checkbox"/>	<input type="checkbox"/>	<input type="checkbox"/>	<input type="checkbox"/>	<input type="checkbox"/>		
						<input type="checkbox"/> ____ mm	<input type="checkbox"/>	<input type="checkbox"/>	<input type="checkbox"/>	<input type="checkbox"/>	<input type="checkbox"/>		

# Modulo d'ordine | Intelaiatura rapida Z75 | Ferramenta

Data \_\_\_\_\_ pagina \_\_\_\_\_ di \_\_\_\_\_ Commissione \_\_\_\_\_ Codice cliente \_\_\_\_\_

### Con montaggio preliminare

- Pacchetto 1 – bandella express tedesca
- Pacchetto 2 – bandella express francese
- Pacchetto 3 – bandella express ISO
- Pacchetto Easyflex D1
- Pacchetto Easyflex CH1
- Pacchetto Easyflex F
- Pacchetto Easyflex D2
- Pacchetto Easyflex CH2

### Senza montaggio preliminare

- Cerniera a T – tedesca
- Bandella lunga ISO
- Bandella Easyflex D
- Bandella Easyflex F
- Pacchetto Easyflex D1
- Pacchetto Easyflex CH1
- Pacchetto Easyflex F
- Cerniera a T – francese
- Bandella Easyflex CH
- Pacchetto Easyflex D2
- Pacchetto Easyflex CH2

- Chiusura e traversa persiana
- Spagnoletta
- Cremagliera e gancio antivento
- Chiudipersiana e cardini angolari
- Fermapersiana standard M10
- Fermapersiana con pastorella M10
- Fermo M10
- Arresto a trazione\*
- Arresto a scatto\*

\* Impossibile con Easyflex®

## Informazioni supplementari | Intelaiatura rapida Z75

Pos.	Informazione supplementare



**EHRET GmbH**

Bahnhofstrasse 14-18

D-77972 Mahlberg

Tel. +49(0) 78 22/439-0

Fax +49(0) 78 22/439-116

[www.ehret.com](http://www.ehret.com)

Made in Germany

© 10.2020 EHRET GmbH | F12.I | Con riserva di modifiche tecniche