

## Bastidor rápido Z75

Marcos de montaje/bastidores



Formulario de Solicitud  
de Oferta / Pedido

# Esquemas de apertura

La vista es siempre desde el interior.

Tendremos en cuenta las medidas de deducción de forma estándar.

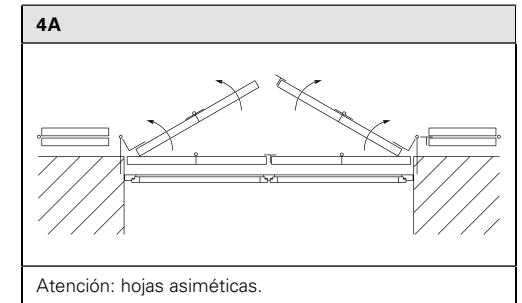
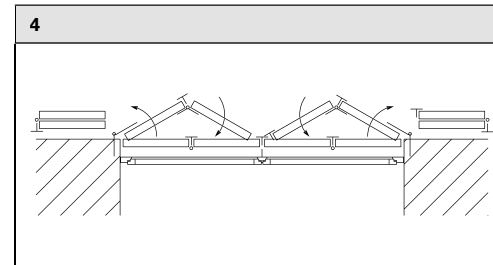
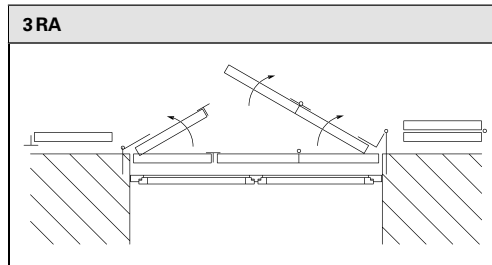
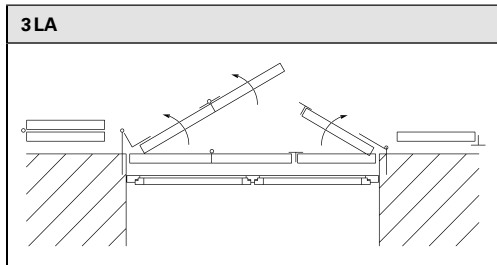
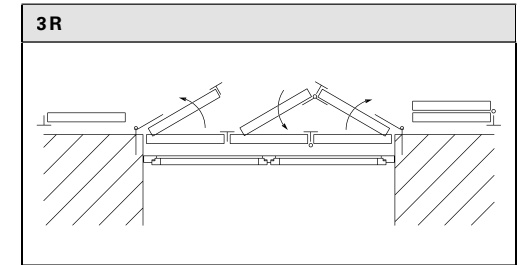
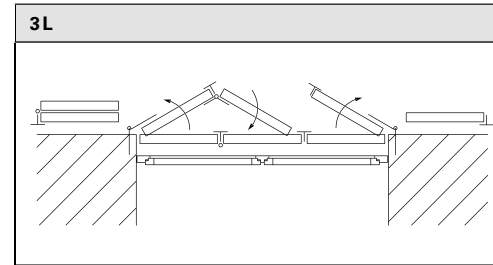
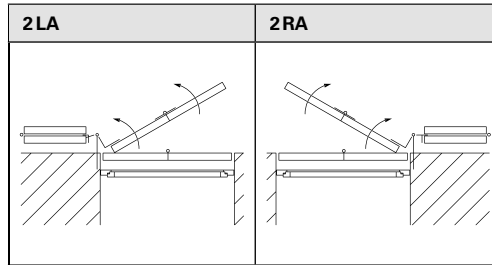
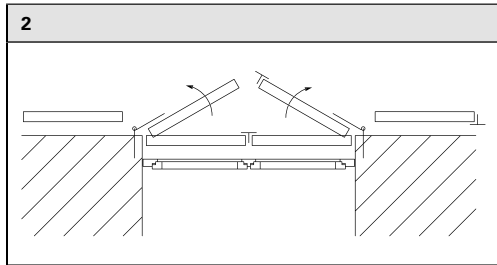
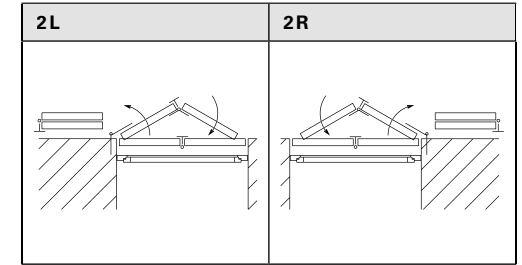
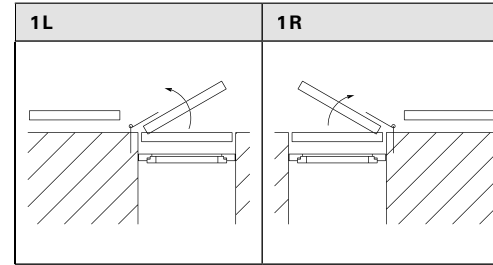

# Toma de medidas

► Medidas tomadas por medidas de hueco (ancho / altura) y esquema de apertura!

## Altura hueco

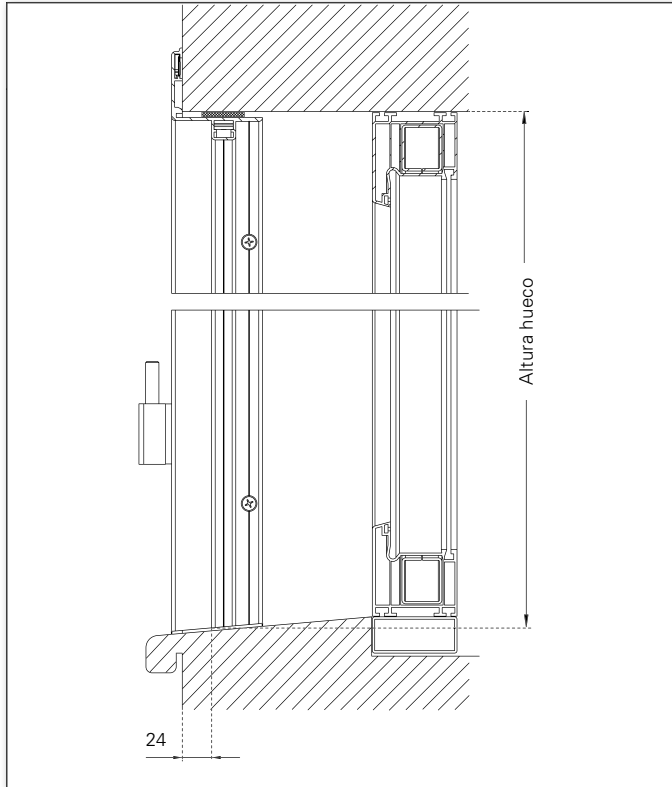

- En caso necesario, el propietario debe ajustar la inclinación del vierteaguas.

### Medidas de deducción (de EHRET)

- Anchura hueco: -10mm
- Altura hueco 3 lados: -5mm
- Altura hueco 4 lados: -8mm

Tendremos en cuenta las medidas de deducción indicadas de forma estándar.

## Anchura hueco

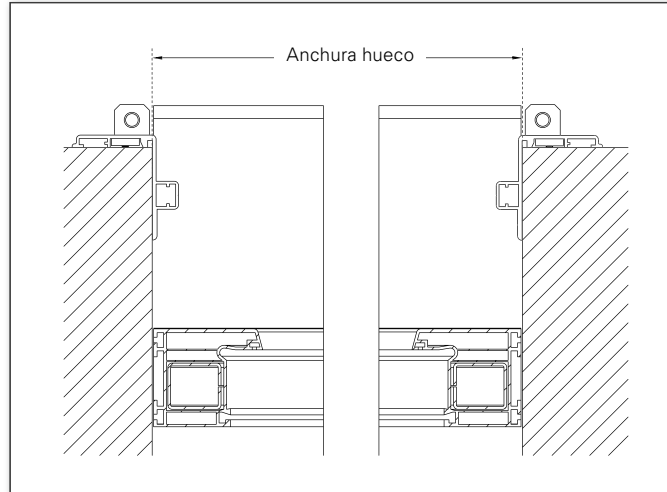

## Opción aumento de altura para corte inclinado de bastidor

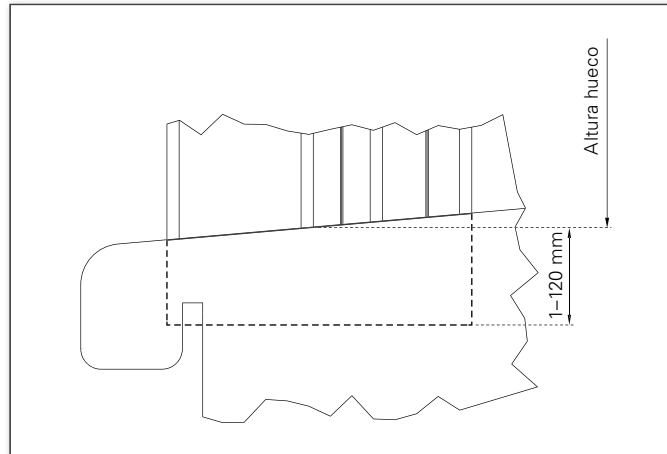

## Dimensiones del bastidor

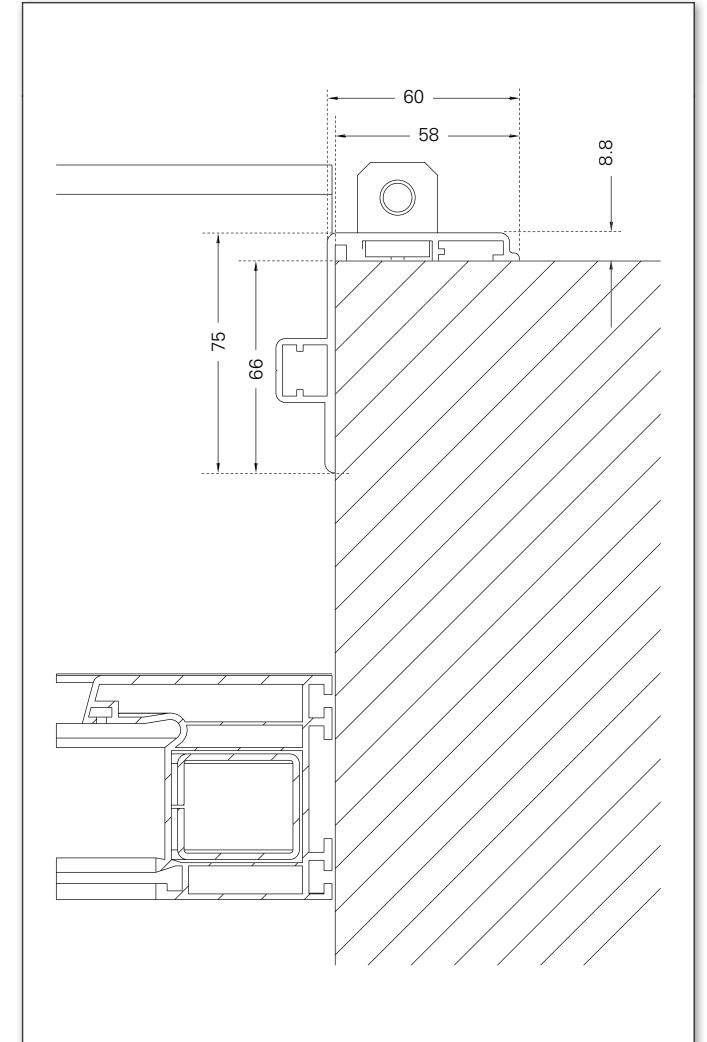

# Paquete de premontaje

Paquete 1 Alemán

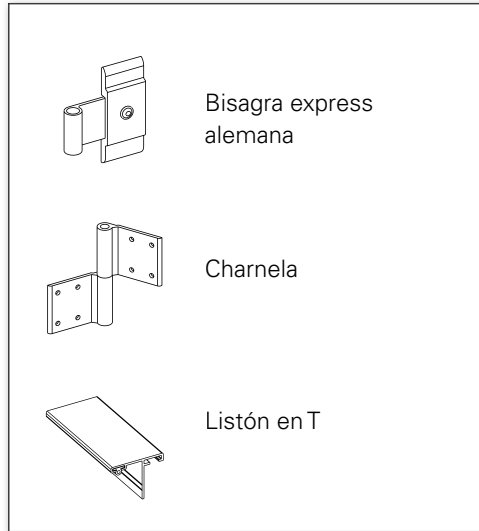

Paquete 2 Francés

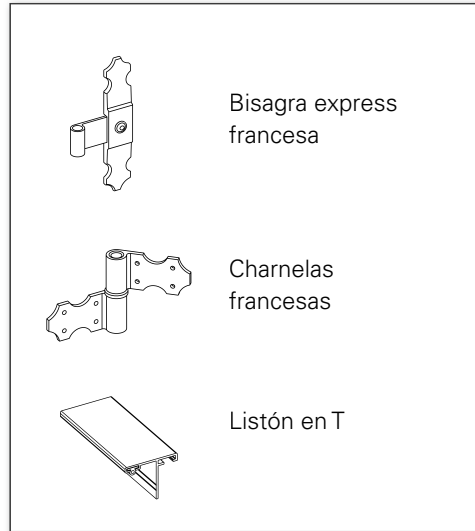



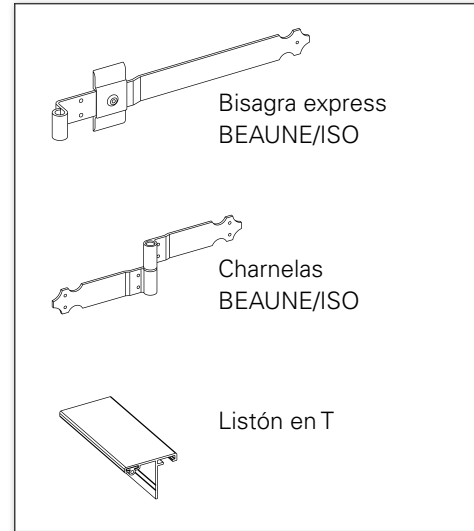





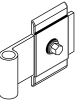
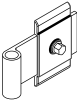
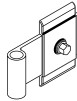
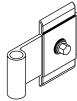
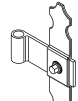
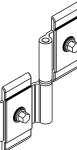
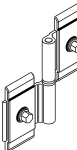
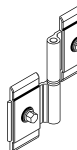
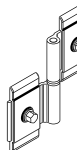
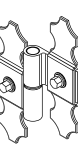
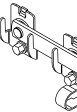
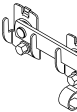
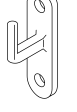
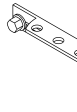
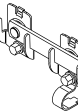

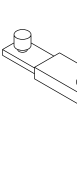
Paquete 3 BEAUNE/ISO



# Paquetes de herraje | Easyflex | con/sin premontaje

## Modelos Easyflex

Easyflex D1	Easyflex D2	Easyflex CH1	Easyflex CH2	Easyflex F
 <p>Bisagra Easyflex</p>	 <p>Bisagra Easyflex</p>	 <p>Bisagra Easyflex</p>	 <p>Bisagra Easyflex</p>	 <p>Bisagra Easyflex F</p>
 <p>Charnela Easyflex</p>	 <p>Charnela Easyflex</p>	 <p>Charnela Easyflex</p>	 <p>Charnela Easyflex</p>	 <p>Charnela Easyflex F</p>
 <p>Cierre de contraventana Easyflex *</p>	 <p>Cierre de contraventana Easyflex*</p>	 <p>Gozne angular o para marco</p>	 <p>Listón de contraventana Easyflex*</p>	 <p>Cierre de contraventana Easyflex*</p>
 <p>Gancho contra viento Easyflex* (con argolla)</p>	 <p>Pasador de contraventana Easyflex*</p>	 <p>Acoplamiento del gancho Easyflex*</p>	 <p>Varillas de la persiana*</p>	 <p>Cierre de varilla de españoleta Maco Easyflex*</p>
 <p>+ Listón en T + Casquillos de reducción</p>	 <p>+ Listón en T + Casquillos de reducción</p>	 <p>+ Listón en T + Casquillos de reducción</p>	 <p>+ Listón en T + Casquillos de reducción</p>	 <p>+ Listón en T + Manija de cierre* + Escuadra de bloqueo*</p>

\*Para la opción VOLETRONIC no está incluido en el paquete de premontaje.

# Opciones | Premontaje | Cierre de cremona superpuesta

Marco R75

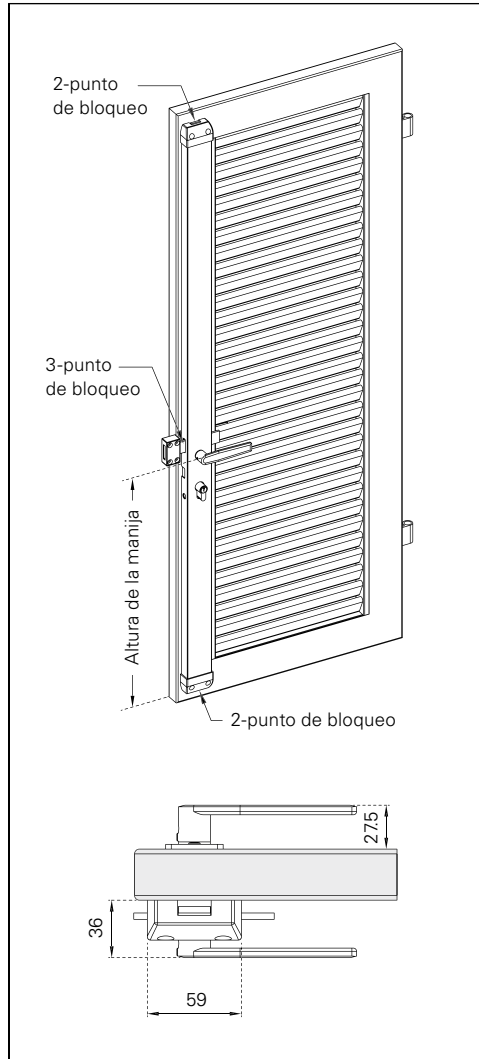

BEAUNE/ISO

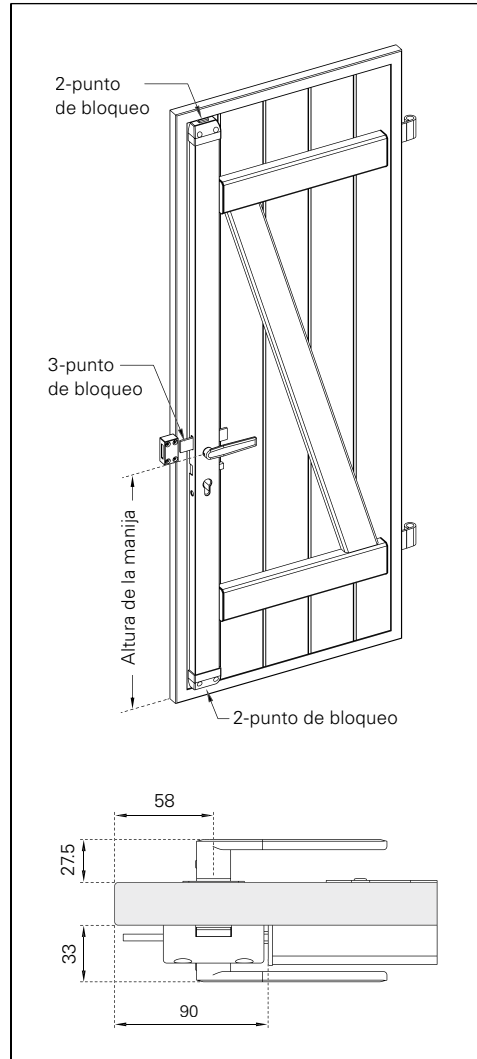

Tipo de montaje 3 en el rebaje

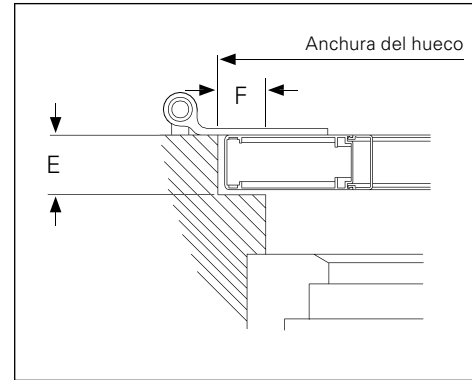

- solo con esquemas 2, 3L/3R, 3LA/3RA, 4

# Formulario | Bastidor rápido Z75

Fecha	Página	de	Obra/Proyecto
Dirección y firma			Modelo de contraventana
Número de cliente			Ocean Line plus <input type="checkbox"/> sí
Encargado			Premontaje <input type="checkbox"/> sí
Plazo deseado			Easyflex® <input type="checkbox"/> sí
Reparto de travesaños			

	<input type="checkbox"/> OFERTA	<input type="checkbox"/> PEDIDO
	Superficie	Gama de color N.º de color
Bastidor	<input type="checkbox"/> FSM <input type="checkbox"/> Acabado <input type="checkbox"/> Otro	<input type="checkbox"/> RAL <input type="checkbox"/> NCS <input type="checkbox"/> VSR
Hojas	<input type="checkbox"/> FSM <input type="checkbox"/> Acabado en madera <input type="checkbox"/> Otro	<input type="checkbox"/> RAL <input type="checkbox"/> NCS <input type="checkbox"/> VSR
Herrajes	<input type="checkbox"/> FSM <input type="checkbox"/> Otro	<input type="checkbox"/> RAL <input type="checkbox"/> NCS <input type="checkbox"/> VSR
EHRET		



Tel. +49 (0) 78 22/439-0  
 Fax +49 (0) 78 22/439-217  
 www.ehret.com

**Nuevo encargo**  
 Obligatorio en caso de nuevos encargos indicar el n.º de pedido original:

--

► Indicar los herrajes en la página extra.

Pos.	Cantidad Elementos	Esquema de apertura	Medidas de hueco			Opcional con suplemento		Premontaje   Cierre de cremona superpuesta					Otros
			Anchura in mm	Altura in mm	Altura más alta Arco medio punto	Aumento de bastidor 1-120 mm	Bastidor de 4 lados	2-punto de bloqueo	3-punto de bloqueo	Manija externamente con cilindro de perfil	Altura de la manija		
						<input type="checkbox"/> ____ mm	<input type="checkbox"/>	<input type="checkbox"/>	<input type="checkbox"/>	<input type="checkbox"/>	<input type="checkbox"/>		
						<input type="checkbox"/> ____ mm	<input type="checkbox"/>	<input type="checkbox"/>	<input type="checkbox"/>	<input type="checkbox"/>	<input type="checkbox"/>		
						<input type="checkbox"/> ____ mm	<input type="checkbox"/>	<input type="checkbox"/>	<input type="checkbox"/>	<input type="checkbox"/>	<input type="checkbox"/>		
						<input type="checkbox"/> ____ mm	<input type="checkbox"/>	<input type="checkbox"/>	<input type="checkbox"/>	<input type="checkbox"/>	<input type="checkbox"/>		
						<input type="checkbox"/> ____ mm	<input type="checkbox"/>	<input type="checkbox"/>	<input type="checkbox"/>	<input type="checkbox"/>	<input type="checkbox"/>		
						<input type="checkbox"/> ____ mm	<input type="checkbox"/>	<input type="checkbox"/>	<input type="checkbox"/>	<input type="checkbox"/>	<input type="checkbox"/>		
						<input type="checkbox"/> ____ mm	<input type="checkbox"/>	<input type="checkbox"/>	<input type="checkbox"/>	<input type="checkbox"/>	<input type="checkbox"/>		
						<input type="checkbox"/> ____ mm	<input type="checkbox"/>	<input type="checkbox"/>	<input type="checkbox"/>	<input type="checkbox"/>	<input type="checkbox"/>		
						<input type="checkbox"/> ____ mm	<input type="checkbox"/>	<input type="checkbox"/>	<input type="checkbox"/>	<input type="checkbox"/>	<input type="checkbox"/>		
						<input type="checkbox"/> ____ mm	<input type="checkbox"/>	<input type="checkbox"/>	<input type="checkbox"/>	<input type="checkbox"/>	<input type="checkbox"/>		





**EHRET GmbH**

Bahnhofstrasse 14-18

D-77972 Mahlberg

Tel. +49(0) 78 22/439-0

Fax +49(0) 78 22/439-116

[www.ehret.com](http://www.ehret.com)

Made in Germany

© 10.2020 EHRET GmbH | F12.S | Reservado el derecho a realizar modificaciones técnicas