

## GLIT

Sliding shutters without visible guide



Order form and  
planning tool

# Stop diagrams

The stop diagrams are sketched as if viewed from inside.

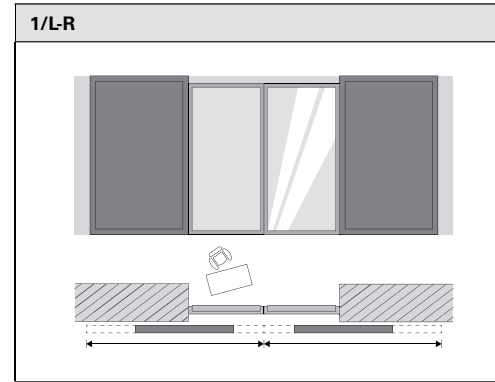
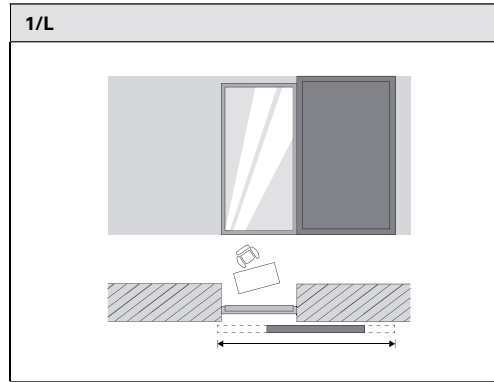
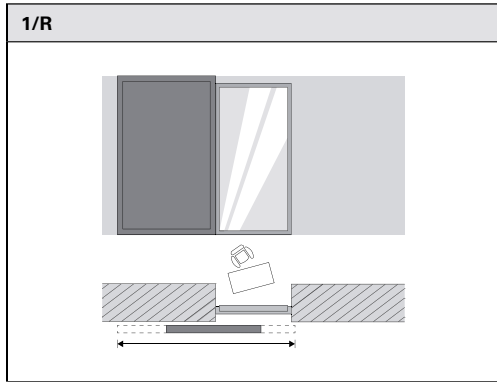

# Measuring instructions for width – diagram 1/L, 1/R

## A Width of support frame



| Clear width    | Support frame    |
|----------------|------------------|
| 320 – 719 mm   | Width 1 (340 mm) |
| 720 – 919 mm   | Width 2 (440 mm) |
| 920 – 1119 mm  | Width 3 (540 mm) |
| 1120 – 1319 mm | Width 4 (640 mm) |
| 1320 – 1400 mm | Width 5 (740 mm) |

## B Width of guide frame

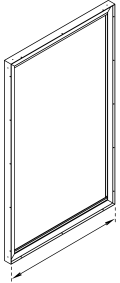

|   |
|---|
| Clear width   |
| + width of support frame  |
| + 50 mm (2x 25 mm profile width of support frame on left/right) |
| + 40 mm (projection at side)                                    |
| <b>= Width of guide frame</b>                                   |

## C Width of sash (shutter)

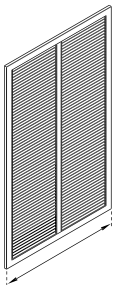

|   |
|---|
| Width of guide frame  |
| - 10 mm (2x 5 mm profile width of guide frame and air, on left/right) |
| <b>= Width of sash (shutter)</b>                                      |

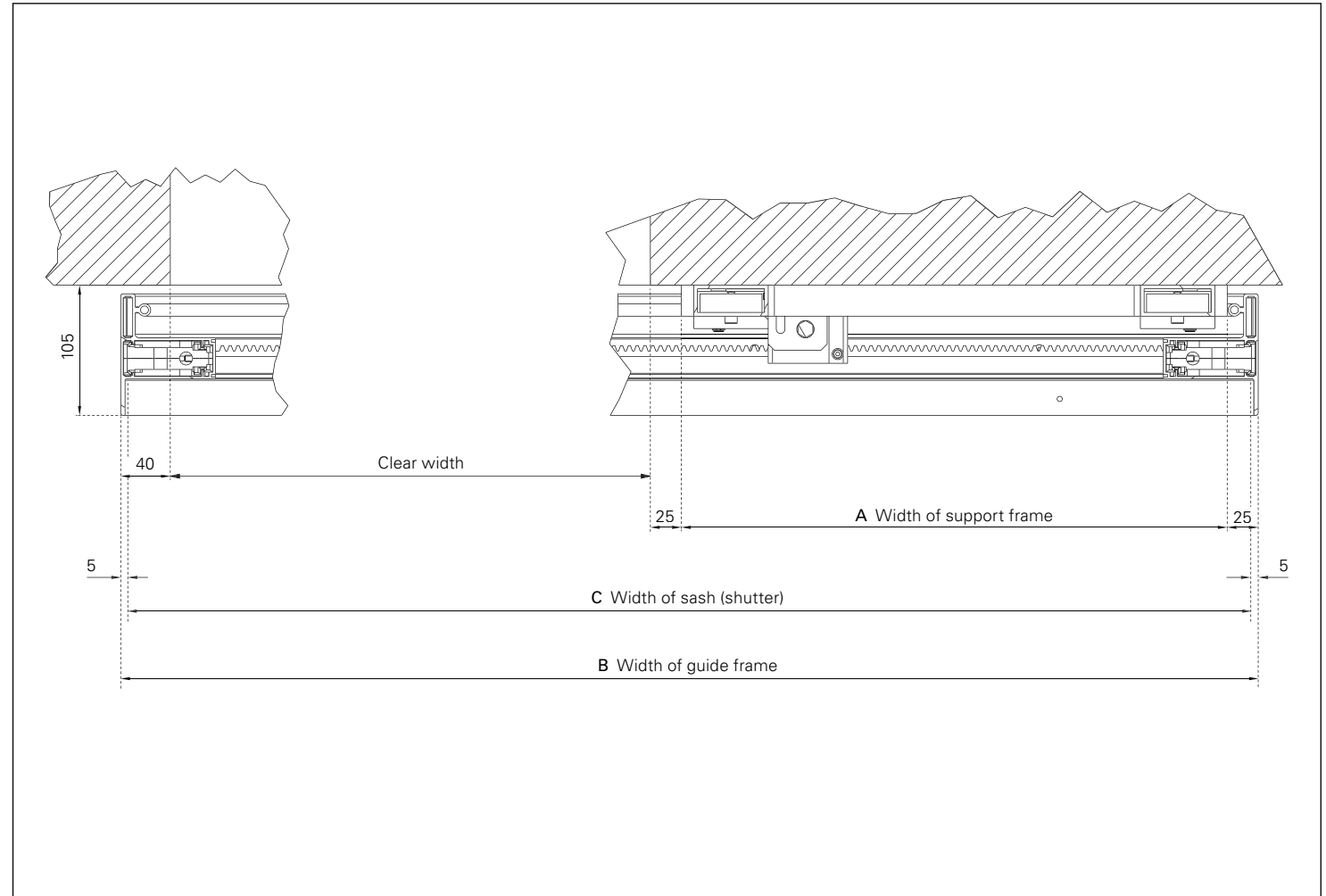

Horizontal section GLIT | closed | diagram 1/L, 1/R

# Measuring instructions for width – diagram 1/L-R

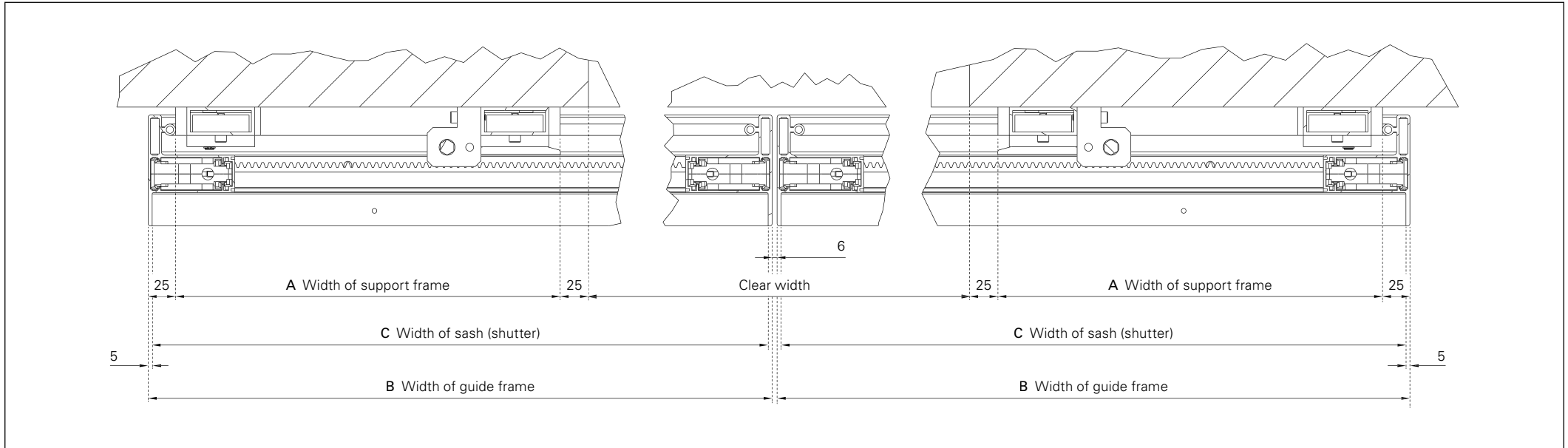

Horizontal section GLIT | closed | diagram 1/L-R

## A Width of support frame



| Clear width ÷ 2 | Support frame    |
|-----------------|------------------|
| 320 – 719 mm    | Width 1 (340 mm) |
| 720 – 919 mm    | Width 2 (440 mm) |
| 920 – 1119 mm   | Width 3 (540 mm) |
| 1120 – 1319 mm  | Width 4 (640 mm) |
| 1320 – 1400 mm  | Width 5 (740 mm) |

## B Width of guide frame

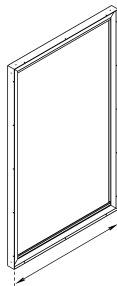

$$\begin{aligned}
 & \text{Clear width} \div 2 \\
 & + \text{width of support frame} \\
 & + 50 \text{ mm} \\
 & \quad (2 \times 25 \text{ mm profile width of support} \\
 & \quad \text{frame on left/right}) \\
 & - 3 \text{ mm } (6 \text{ mm air} \div 2) \\
 & = \text{Width of guide frame}
 \end{aligned}$$

## C Width of sash (shutter)

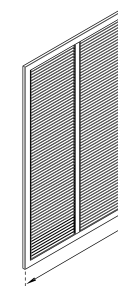

$$\begin{aligned}
 & \text{Width of guide frame} \\
 & - 10 \text{ mm} \\
 & \quad (2 \times 5 \text{ mm profile width of guide} \\
 & \quad \text{frame and air, on left/right}) \\
 & = \text{Width of sash (shutter)}
 \end{aligned}$$

# Measuring instructions for height

## D Height of guide frame

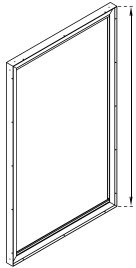

Clear height  
+ projection/distance to reveal (top and bottom)  
= **Height of guide frame**

|             | Projection/distance to reveal |         |
|-------------|-------------------------------|---------|
|             | Top                           | Bottom  |
| Standard    | + 40 mm                       | + 40 mm |
| Window sill | + 40 mm                       | - XX mm |

## E Height of sash (shutter)

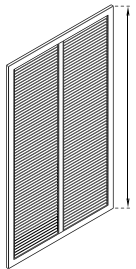

Height of guide frame  
- 10 mm  
(2 x 5 mm profile height of guide frame and air, top and bottom)  
= **Height of sash (shutter)**

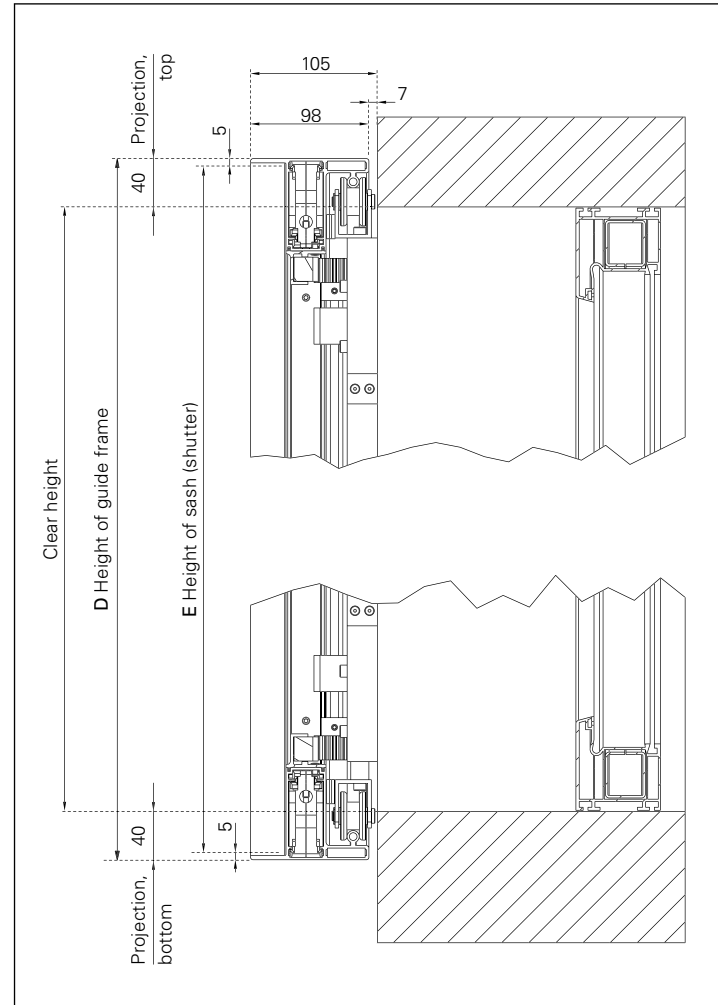

Vertical section GLIT | standard

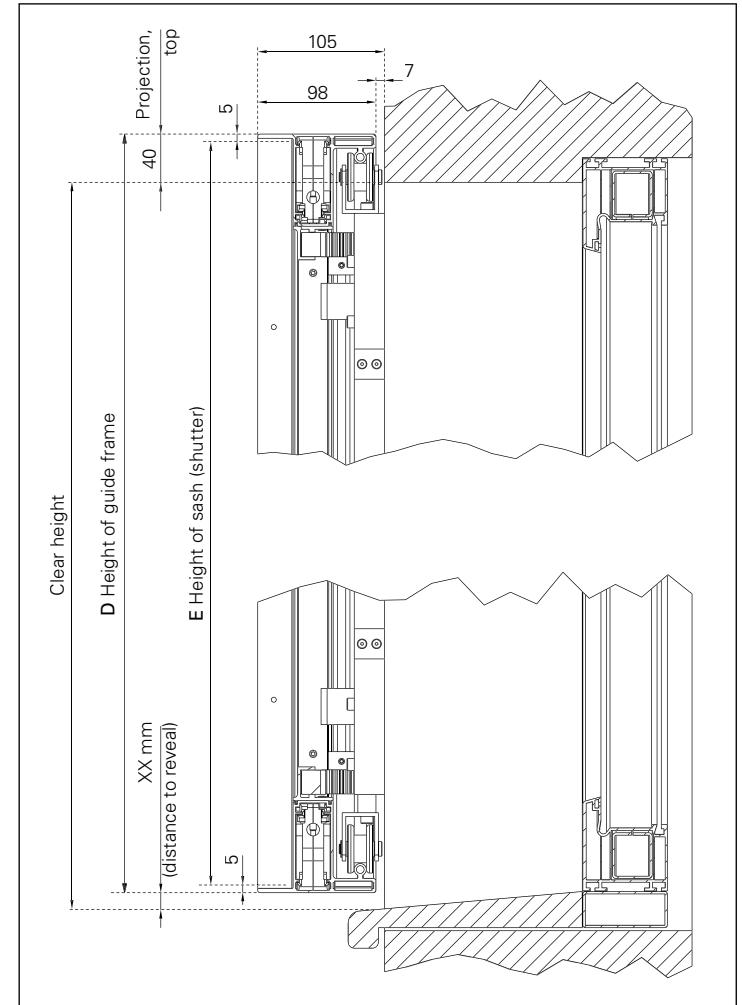

Vertical section GLIT | with window sill

# GLIT models

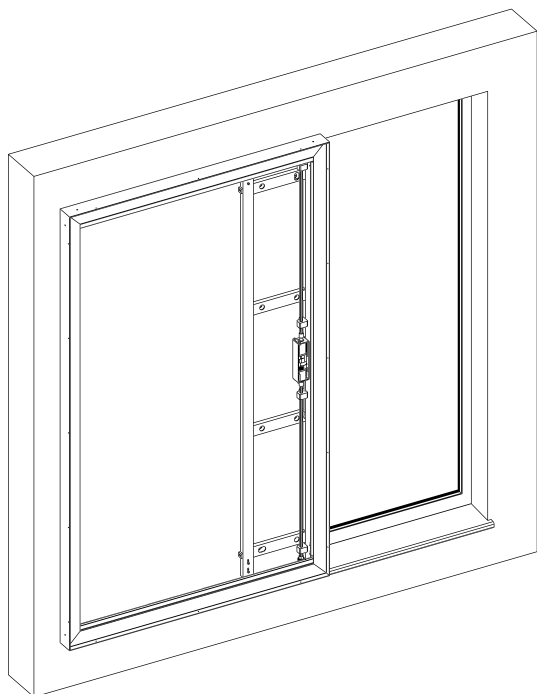

## Model selection

- Frame profiles with 32 mm depth (R75, TZR75, AR61-B1, SL-12);
- Frame profiles with 48 mm depth (MAX15, MAX28, MAX37, CADROTEX) on request.
- Cannot be combined with shutters with moving or overlapping slats.
- Cannot be combined with models with projecting slat carrier profile.

## Operation

- The GLIT can be operated using buttons and/or remote control.
- Corresponding controls and accessories (hand-held transmitter, switches, receiver, cover trim, etc.) are to be placed outside the element and should be obtained directly from the manufacturer (Somfy).

The GLIT sliding system with electric drive can be combined with the following models:

| Fixed slats <sup>(1)</sup> | Closed models        | Insulating models   | Special centres  |
|----------------------------|----------------------|---------------------|------------------|
| SUN-R75 <sup>(2)</sup>     | AMSTERDAM            | TIZO <sup>(2)</sup> | MATRICO          |
| JS                         | TZ                   | TIZO-ROM            | MATRICO-MAX15    |
| MS                         | TZ-ROM               | TIZO-ROM-RS         | MATRICO-MAX28    |
| NICE                       | TZ-PISA              | TIZO-ROM-RW         | CADROTEX         |
| PARIS <sup>(2)</sup>       | TZ-GE                | TIZO-PISA           | NATURE-MAX15     |
| JS-MAX15                   | TZ-GE-SE             | TSW                 | NATURE-SL12-40L  |
| JZN-MAX15                  | TZO                  |                     | NATURE-SL12-40U  |
| MS-MAX15                   | TZO-ROM              |                     | NATURE-SL12-60L  |
| PARIS-MAX15 <sup>(2)</sup> | TSW                  |                     | NATURE-SL12-60U  |
| SL-MAX15                   | PL                   |                     | NATURE-SL12-80L  |
| SUN-MAX15 <sup>(2)</sup>   | PL-N-1               |                     | NATURE-SL12-80U  |
| JS-MAX37                   | PL-LO                |                     | NATURE-SL12-100L |
| MS-MAX37                   | PL-LO-N              |                     | NATURE-SL12-100U |
| PARIS-MAX37                | PLANO                |                     |                  |
| SL-MAX37                   | PLANO-MAX28          |                     |                  |
| SUN-MAX37 <sup>(2)</sup>   | VARIO                |                     |                  |
| SL-R75                     | VARIO-MAX28          |                     |                  |
|                            | LINEA <sup>(2)</sup> |                     |                  |

<sup>(1)</sup> In models with fixed slats, the guide frame is visible at some angles.

<sup>(2)</sup> Increased total weight due to heavy insert

- GLIT models must not exceed a total weight (guide frame + shutter model) of 45 kg!
- Min./max. dimensions guide frame: Width: 700 to 2230 mm, Height: 1010 to 2500 mm
- Min./max. dimensions clear measurements: Width: 320 to 1400 mm, Height: 930 to 2420 mm

# Order form | GLIT

Date \_\_\_\_\_ Page \_\_\_\_\_ of \_\_\_\_\_

Your address and signature \_\_\_\_\_

\_\_\_\_\_

\_\_\_\_\_

Your customer number \_\_\_\_\_

\_\_\_\_\_

Your processor \_\_\_\_\_

\_\_\_\_\_

Preferred delivery date \_\_\_\_\_

\_\_\_\_\_

Ocean Line plus  yes

Consignment \_\_\_\_\_

\_\_\_\_\_

Shutter model \_\_\_\_\_

\_\_\_\_\_

Split with combi models \_\_\_\_\_

\_\_\_\_\_

Motor adjustment and inspection unit V3  
 Art. no. 871057

\_\_\_\_\_

**Real-wood slats\*** Slat height

NATURE-MAX15  60 mm

NATURE-SL12  40 mm  60 mm

80 mm  100 mm

\_\_\_\_\_

Pretreatment  Untreated

Glazed on reverse

\_\_\_\_\_

\*Type of wood: Siberian larch, planed surface,  
other woods available on request.

|               | <input type="checkbox"/> OFFER   | <input type="checkbox"/> ORDER   |
|---------------|--|--|
|               | Surface  | Colour system Colour number  |
| GLIT          | <input type="checkbox"/> FSM   | <input type="checkbox"/> RAL   |
| Guide frame   | <input type="checkbox"/> Silk gloss<br><input type="checkbox"/> Matt<br><input type="checkbox"/> Wood finish | <input type="checkbox"/> NCS<br><input type="checkbox"/> VSR<br><input type="checkbox"/> Various |
| GLIT          | <input type="checkbox"/> FSM   | <input type="checkbox"/> RAL   |
| Carrier frame | <input type="checkbox"/> Silk gloss<br><input type="checkbox"/> Matt   | <input type="checkbox"/> NCS<br><input type="checkbox"/> VSR<br><input type="checkbox"/> Various |
| with motor    | <input type="checkbox"/> Matt  | <input type="checkbox"/> VSR<br><input type="checkbox"/> Various                                 |
| Shutter       | <input type="checkbox"/> FSM   | <input type="checkbox"/> RAL   |
| Frame         | <input type="checkbox"/> Silk gloss<br><input type="checkbox"/> Matt<br><input type="checkbox"/> Wood finish | <input type="checkbox"/> NCS<br><input type="checkbox"/> VSR<br><input type="checkbox"/> Various |
| Shutter       | <input type="checkbox"/> FSM   | <input type="checkbox"/> RAL   |
| Insert        | <input type="checkbox"/> Silk gloss<br><input type="checkbox"/> Matt<br><input type="checkbox"/> Wood finish | <input type="checkbox"/> NCS<br><input type="checkbox"/> VSR<br><input type="checkbox"/> Various |



**EHRET GmbH**  
 Aluminium Shutters  
 Bahnhofstrasse 14-18  
 D-77972 Mahlberg  
 Tel. +49 (0) 78 22/439-0  
 Fax +49 (0) 78 22/439-217  
[www.ehret.com](http://www.ehret.com)

► Please order controls and accessories directly from the manufacturer (Somfy)!

| Item | Number of elements | Stop diagram             |                          |                          | Sashes in total | Clear dimensions |              | Precise finished dimensions<br><small>External dimensions of guide frame</small> |        | Projection |        |             | Distance to reveal | Miscellaneous |
|------|--------------------|--------------------------|--------------------------|--------------------------|-----------------|------------------|--------------|--|--------|------------|--------|-------------|--------------------|---------------|
|      |                    | 1/L                      | 1/R                      | 1/L-R                    |                 | Clear width      | Clear height | Width  | Height | Top        | Bottom | On the side | Bottom             |               |
|      |                    | <input type="checkbox"/> | <input type="checkbox"/> | <input type="checkbox"/> |                 |                  |              |  |        |            |        |             |                    |               |
|      |                    | <input type="checkbox"/> | <input type="checkbox"/> | <input type="checkbox"/> |                 |                  |              |  |        |            |        |             |                    |               |
|      |                    | <input type="checkbox"/> | <input type="checkbox"/> | <input type="checkbox"/> |                 |                  |              |  |        |            |        |             |                    |               |
|      |                    | <input type="checkbox"/> | <input type="checkbox"/> | <input type="checkbox"/> |                 |                  |              |  |        |            |        |             |                    |               |
|      |                    | <input type="checkbox"/> | <input type="checkbox"/> | <input type="checkbox"/> |                 |                  |              |  |        |            |        |             |                    |               |
|      |                    | <input type="checkbox"/> | <input type="checkbox"/> | <input type="checkbox"/> |                 |                  |              |  |        |            |        |             |                    |               |
|      |                    | <input type="checkbox"/> | <input type="checkbox"/> | <input type="checkbox"/> |                 |                  |              |  |        |            |        |             |                    |               |
|      |                    | <input type="checkbox"/> | <input type="checkbox"/> | <input type="checkbox"/> |                 |                  |              |  |        |            |        |             |                    |               |
|      |                    | <input type="checkbox"/> | <input type="checkbox"/> | <input type="checkbox"/> |                 |                  |              |  |        |            |        |             |                    |               |

# Additional information | GLIT

Date \_\_\_\_\_ Page \_\_\_\_\_ of \_\_\_\_\_ Consignment \_\_\_\_\_ Your customer number \_\_\_\_\_

| Item | Additional information |
|------|------------------------|
|      |                        |
|      |                        |
|      |                        |
|      |                        |
|      |                        |
|      |                        |
|      |                        |
|      |                        |
|      |                        |
|      |                        |
|      |                        |
|      |                        |
|      |                        |
|      |                        |
|      |                        |
|      |                        |
|      |                        |
|      |                        |
|      |                        |
|      |                        |
|      |                        |
|      |                        |
|      |                        |
|      |                        |
|      |                        |
|      |                        |



**EHRET GmbH**

Bahnhofstrasse 14-18

D-77972 Mahlberg

Tel. +49(0) 78 22/439-0

Fax +49(0) 78 22/439-116

[www.ehret.com](http://www.ehret.com)

**Made in Germany**

© 07.2017 EHRET GmbH | F22.E | Subject to technical modifications