

Schnellzarge Z135

Montagerahmen / Zargen



Bestellformular
und Planungshilfe

Anschlagschemen

Ansichten jeweils von innen!

Abzugsmaße werden von uns standardmäßig berücksichtigt.

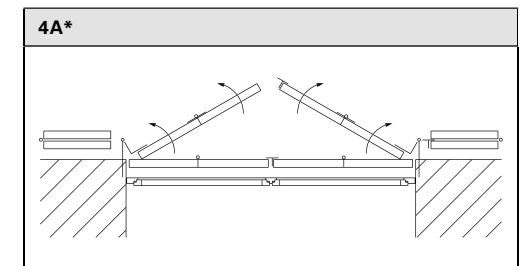
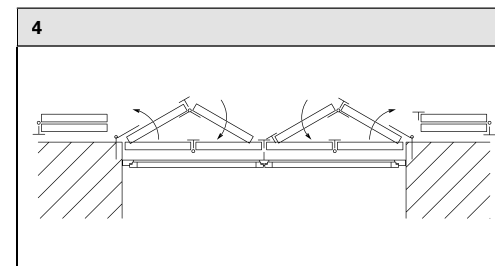
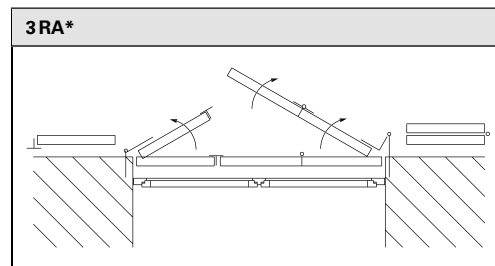
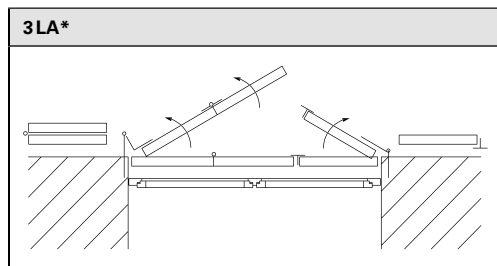
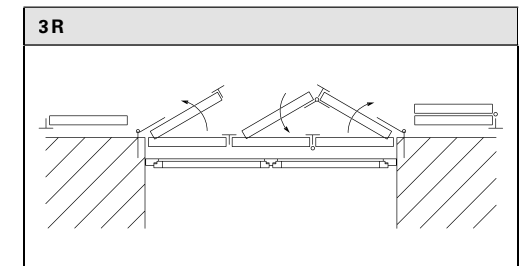
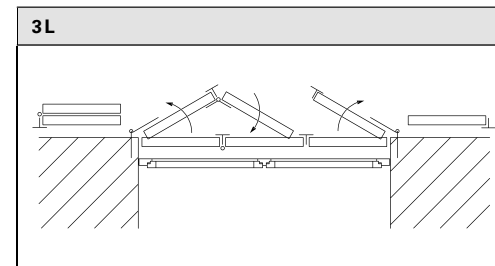
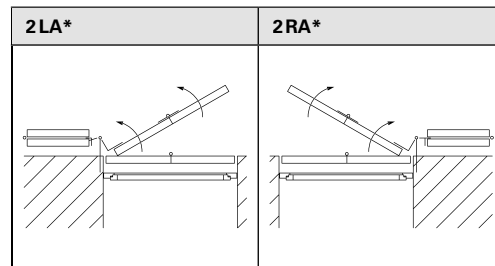
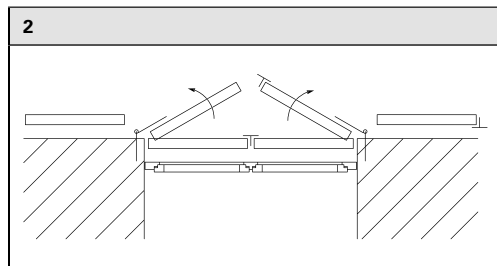
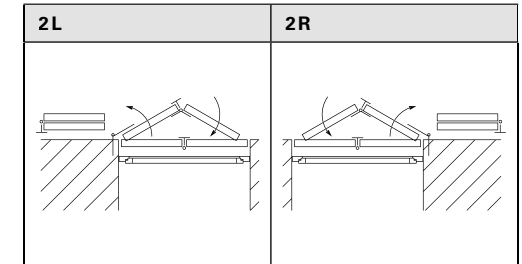
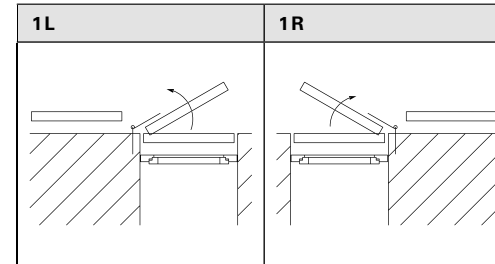

*Schemen 2LA/RA, 3LA/RA, 4A nicht möglich bei Option VOLETRONIC!

Maßanleitung | Schnellzarge Z135

Maßaufnahme | Lichte Breite/Höhe und Anschlagsschema

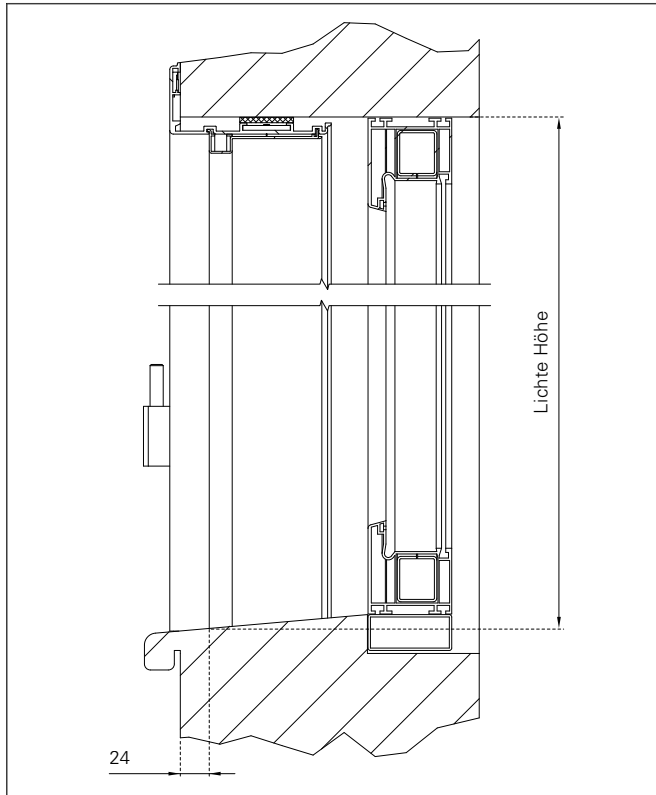

- Fensterbankschräge muß ggf. bauseits angepasst werden!

Abzugsmaße (von EHRET)

- Lichte Breite: -10 mm
- Lichte Höhe 3-seitig: -5 mm
- Lichte Höhe 4-seitig: -8 mm

Die angegebenen Abzugsmaße werden von uns standardmäßig berücksichtigt.

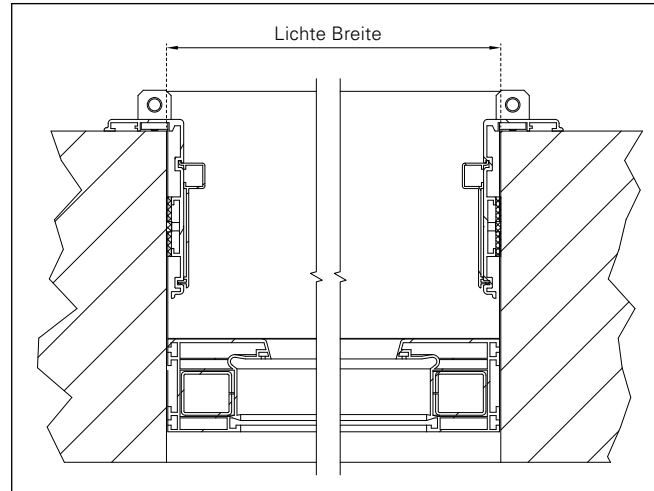

Option | Zargenverlängerung (1-120 mm)

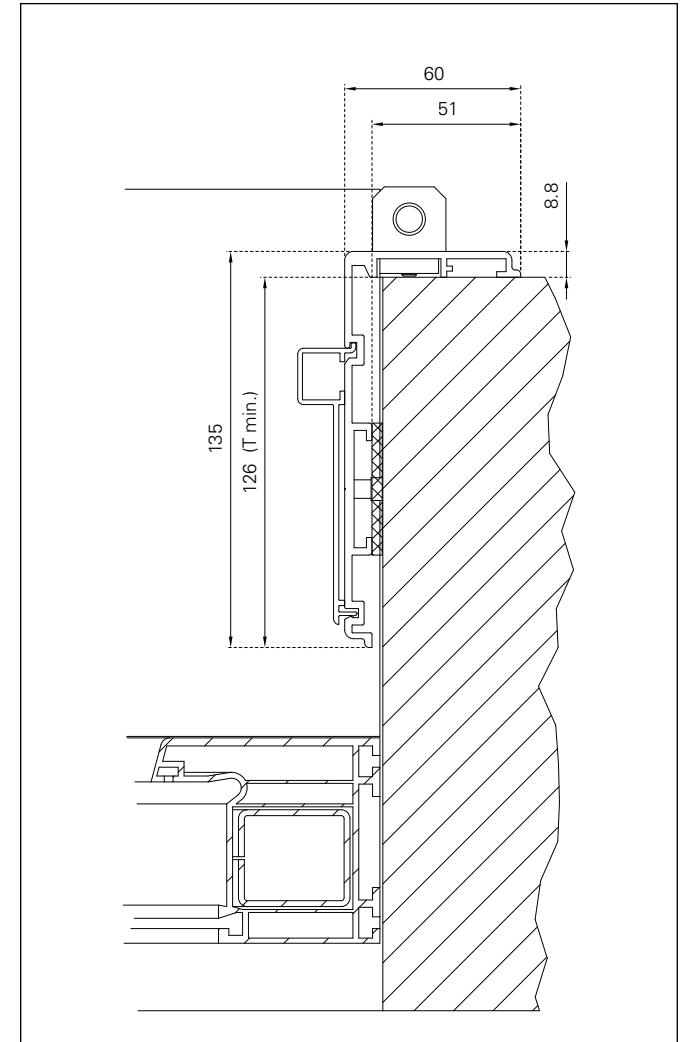
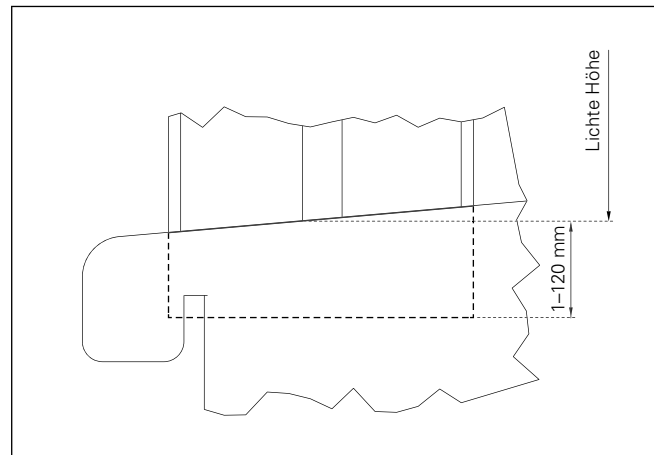

Maßanleitung | Schnellzarge Z135 + Voletronic

Maßaufnahme | Lichte Breite/Höhe und Anschlagsschema

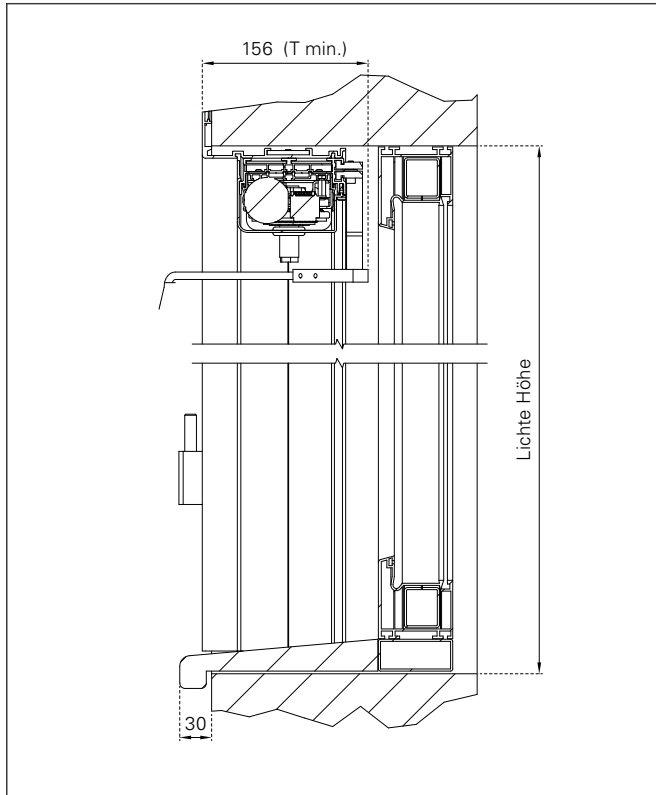

- Fensterbankschräge muß ggf. bauseits angepasst werden!

Abzugsmaße (von EHRET)

- Lichte Breite: -10 mm
- Lichte Höhe 3-seitig: -5 mm
- Lichte Höhe 4-seitig: -8 mm

Die angegebenen Abzugsmaße werden von uns standardmäßig berücksichtigt.

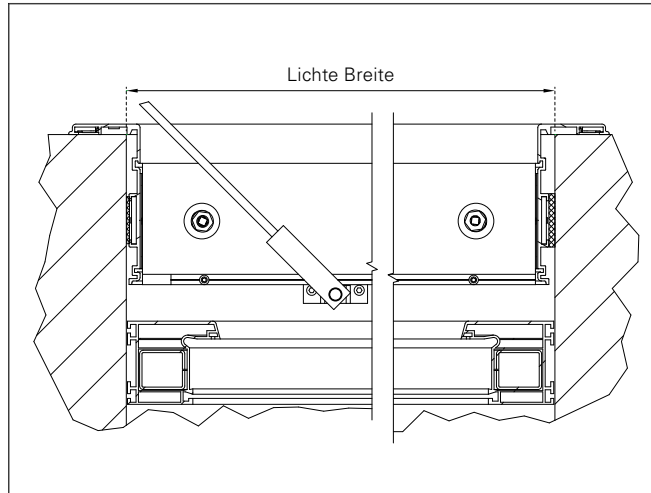

Option | Zargenverlängerung (1-120 mm)

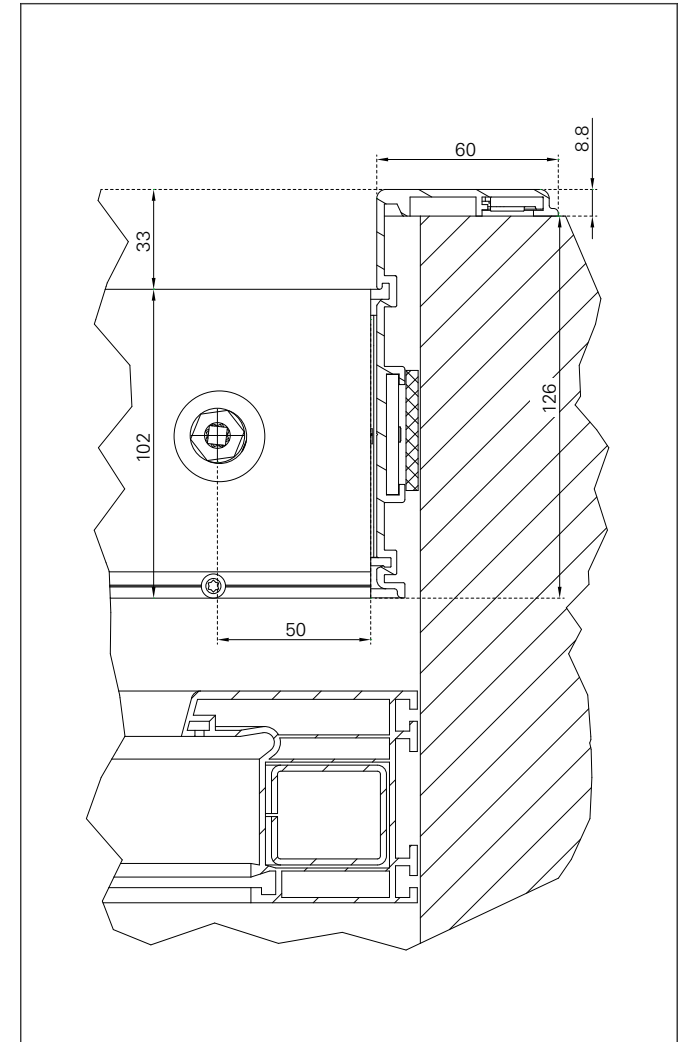
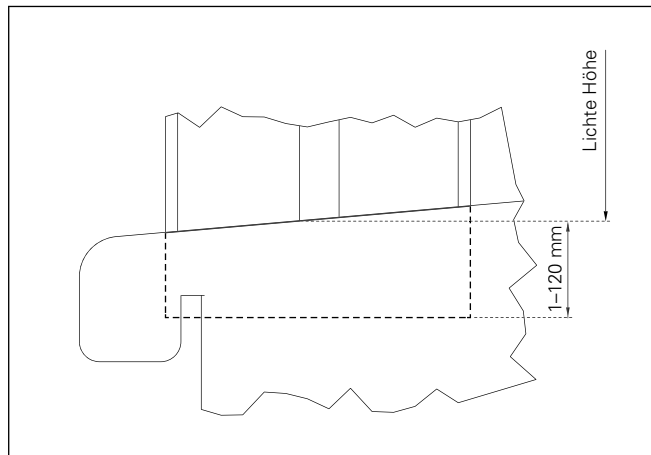

Maßanleitung

Schnellzarge Z135

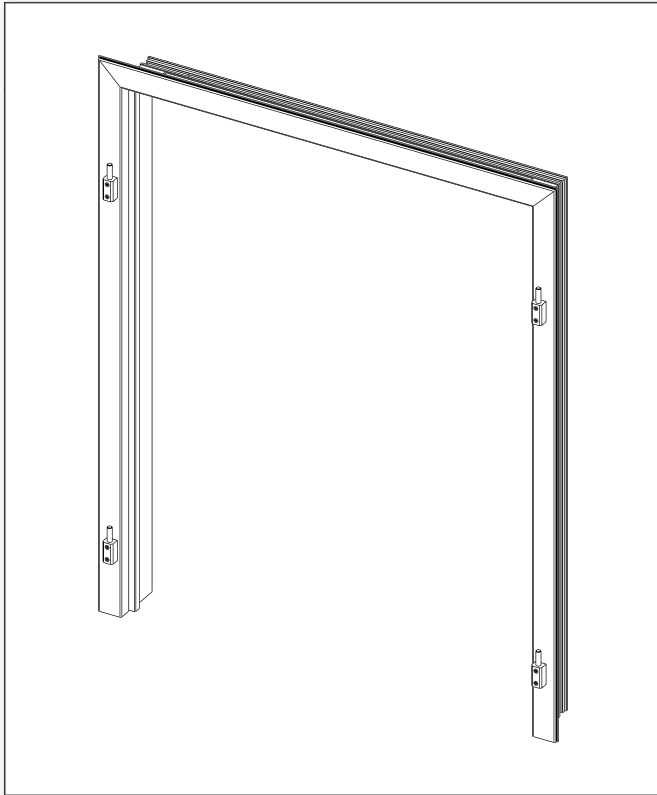

- T-Maß = min. 126 mm

Lichte Breite	Lichte Höhe
500 – 2800 mm	800 – 2500 mm

Schnellzarge Z135 + VOLETRONIC

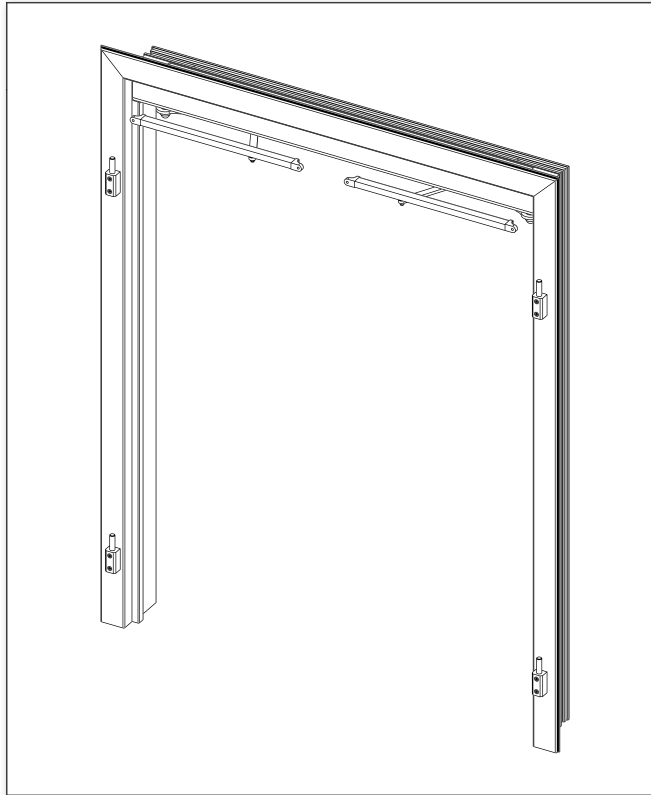

- T-Maß = min. 156 mm

Schema	Lichte Breite
1R/1L	623 – 840 mm
2R/2L	623 – 1644 mm
2	913 – 1644 mm
3R/3L	913 – 2451 mm
4	1177 – 2530 mm

Vormontagepakete

Paket 1 deutsch

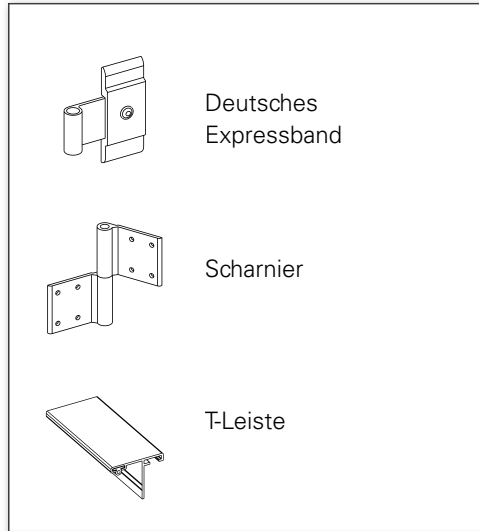

Paket 2 französisch

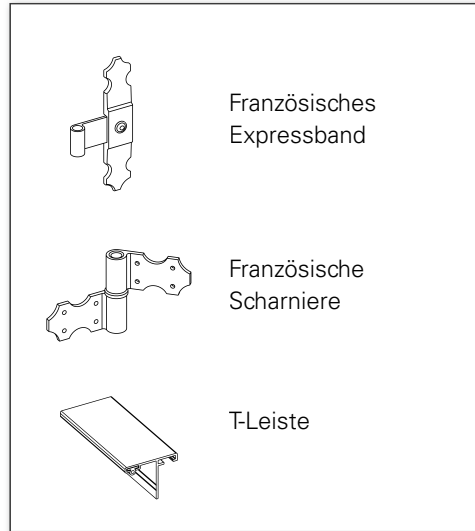

Paket 3 BEAUNE/ISO

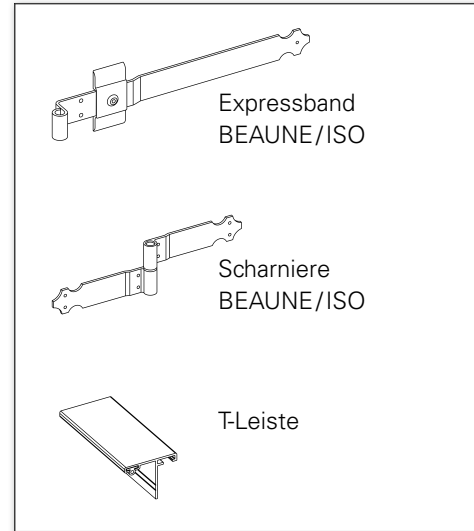

Beschlagspakete | Easyflex | mit/ohne Vormontage

Modelle Easyflex

Easyflex D1

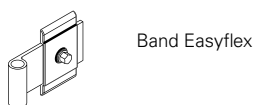

Band Easyflex

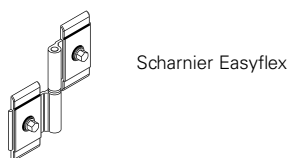

Scharnier Easyflex



Ladenverschluss Easyflex *



Sturmhaken Easyflex*
(mit Plattenöse)

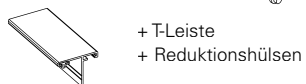

+ T-Leiste
+ Reduktionshülsen

Easyflex D2

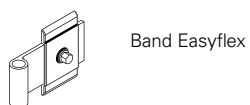

Band Easyflex

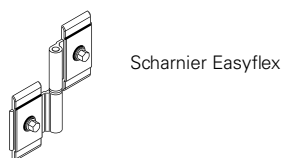

Scharnier Easyflex



Ladenverschluss Easyflex*

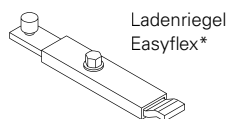

Ladenriegel Easyflex*

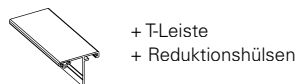

+ T-Leiste
+ Reduktionshülsen

Easyflex CH1

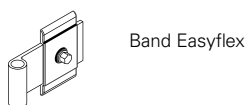

Band Easyflex

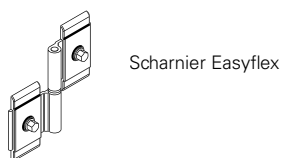

Scharnier Easyflex

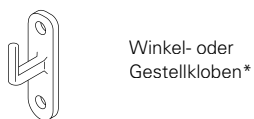

Winkel- oder Gestellkloben*

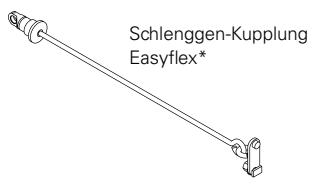

Schlinggen-Kupplung Easyflex*

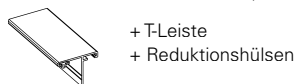

+ T-Leiste
+ Reduktionshülsen

Easyflex CH2



Band Easyflex

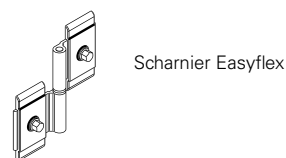

Scharnier Easyflex

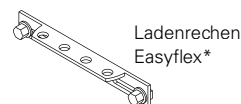

Ladenrechen Easyflex*

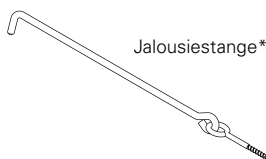

Jalousiestange*

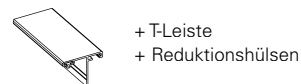

+ T-Leiste
+ Reduktionshülsen

Easyflex F



Band Easyflex F



Scharnier Easyflex F



Ladenverschluss Easyflex*

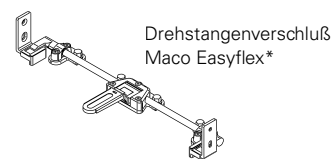

Drehstangenverschuß Maco Easyflex*



+ T-Leiste
+ Zuziehgriff*
+ Verriegelungswinkel*

*nicht im Vormontagepaket enthalten bei Option VOLETRONIC!

Optionen | Vormontage | Aufbauschloss

Rahmen R75

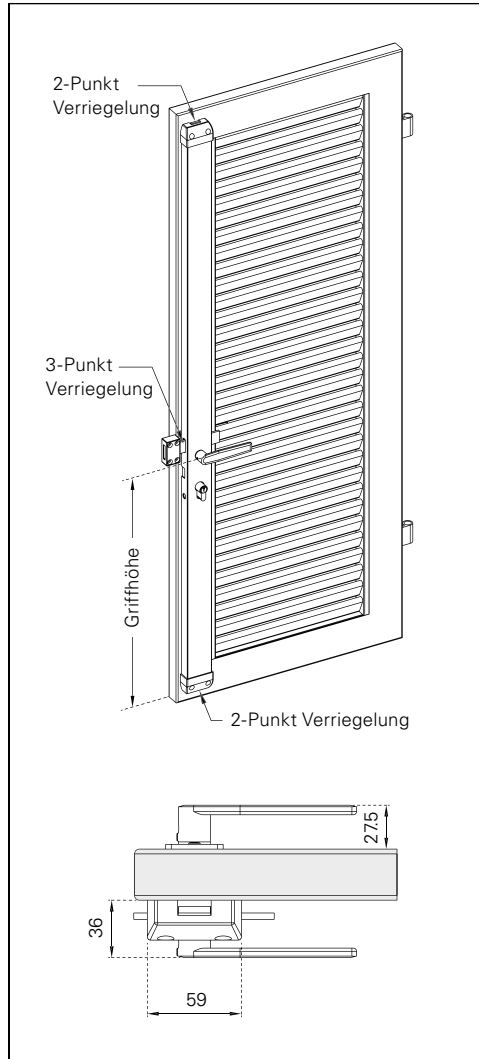

BEAUNE/ISO

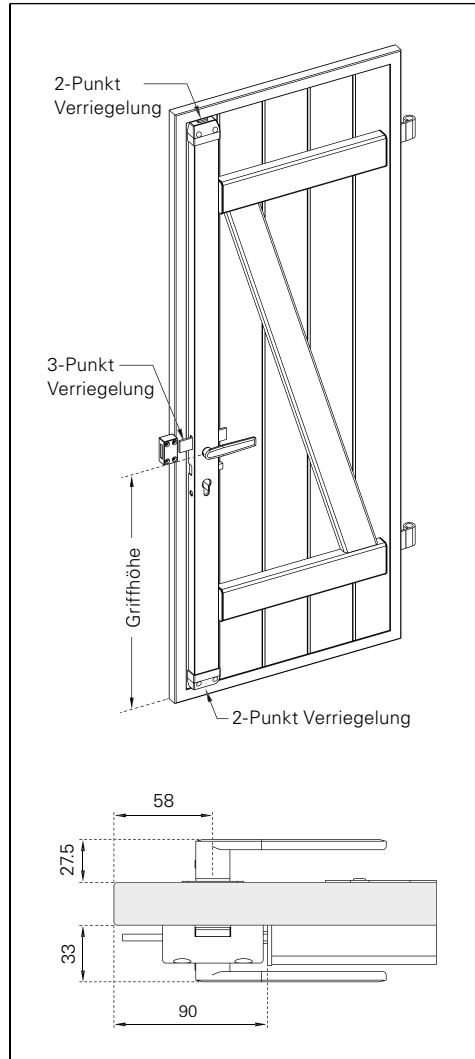

Montageart 3 im Falz

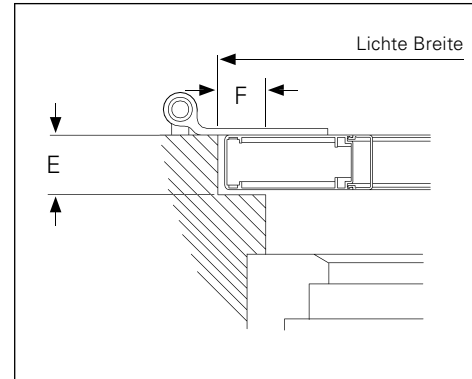

• nur mit Schema 2, 3L/3R, 3LA/3RA, 4

Bestellformular | Schnellzarge Z135

Datum _____ Seite _____ von _____
 Ihre Adresse und Unterschrift _____

Kommission _____
 Klappladenmodell _____

Aufteilung bei Kombimodellen _____

Ihre Kundennummer _____
 Ihr Sachbearbeiter _____
 gewünschter Termin _____

Ocean Line plus ja
 Vormontage ja

▶ Beschläge/Beschlagspakete bitte auf der Extra-Seite eintragen!

	<input type="checkbox"/> ANGEBOT	<input type="checkbox"/> AUFTRAG	
	<i>Oberfläche</i>	<i>Farbsystem</i>	<i>Farbnummer</i>
Zarge*	<input type="checkbox"/> FSM <input type="checkbox"/> Dekor <input type="checkbox"/> Divers	<input type="checkbox"/> RAL <input type="checkbox"/> NCS <input type="checkbox"/> VSR	
Flügel*	<input type="checkbox"/> FSM <input type="checkbox"/> Holzdekor <input type="checkbox"/> Divers	<input type="checkbox"/> RAL <input type="checkbox"/> NCS <input type="checkbox"/> VSR	
Beschläge	<input type="checkbox"/> FSM <input type="checkbox"/> Divers	<input type="checkbox"/> RAL <input type="checkbox"/> NCS <input type="checkbox"/> VSR	

*Bei Zarge mit Antrieb: Gehäuse in Zargenfarbe; Bügel und Führungsschienen in Flügel Farbe (bei Dekor in Komplementärfarbe). Abweichungen bitte auf der Extra-Seite eintragen!



Tel. +49 (0) 78 22/439-0
 Fax +49 (0) 78 22/439-217
 www.ehret.com

Nachbestellung
 bei Nachlieferungen unbedingt
 ursprüngliche Auftrags-Nr. angeben:

Pos.	Anzahl Elemente	Anschlagschema	Lichte Maße		Zargenverlängerung 1-120 mm	VOLETRONIC 230 V								Vormontage Aufbauschloss					Sonstiges
			Lichte Breite in mm	Lichte Höhe in mm		Zarge mit Antrieb	Kabelausgang links	Kabelausgang rechts	Handsender 1-Kanal	Handsender 5-Kanal	Handsender 16-Kanal	zusätzlicher Wandsender	2-Punkt-Verriegelung	3-Punkt-Verriegelung	Griff außen	mit Profizylinder	Griffhöhe		
					<input type="checkbox"/> ____ mm	<input type="checkbox"/>	<input type="checkbox"/>	<input type="checkbox"/>	<input type="checkbox"/>	<input type="checkbox"/>	<input type="checkbox"/>	<input type="checkbox"/>	<input type="checkbox"/>	<input type="checkbox"/>	<input type="checkbox"/>	<input type="checkbox"/>	<input type="checkbox"/>		
					<input type="checkbox"/> ____ mm	<input type="checkbox"/>	<input type="checkbox"/>	<input type="checkbox"/>	<input type="checkbox"/>	<input type="checkbox"/>	<input type="checkbox"/>	<input type="checkbox"/>	<input type="checkbox"/>	<input type="checkbox"/>	<input type="checkbox"/>	<input type="checkbox"/>	<input type="checkbox"/>		
					<input type="checkbox"/> ____ mm	<input type="checkbox"/>	<input type="checkbox"/>	<input type="checkbox"/>	<input type="checkbox"/>	<input type="checkbox"/>	<input type="checkbox"/>	<input type="checkbox"/>	<input type="checkbox"/>	<input type="checkbox"/>	<input type="checkbox"/>	<input type="checkbox"/>	<input type="checkbox"/>		
					<input type="checkbox"/> ____ mm	<input type="checkbox"/>	<input type="checkbox"/>	<input type="checkbox"/>	<input type="checkbox"/>	<input type="checkbox"/>	<input type="checkbox"/>	<input type="checkbox"/>	<input type="checkbox"/>	<input type="checkbox"/>	<input type="checkbox"/>	<input type="checkbox"/>	<input type="checkbox"/>		
					<input type="checkbox"/> ____ mm	<input type="checkbox"/>	<input type="checkbox"/>	<input type="checkbox"/>	<input type="checkbox"/>	<input type="checkbox"/>	<input type="checkbox"/>	<input type="checkbox"/>	<input type="checkbox"/>	<input type="checkbox"/>	<input type="checkbox"/>	<input type="checkbox"/>	<input type="checkbox"/>		
					<input type="checkbox"/> ____ mm	<input type="checkbox"/>	<input type="checkbox"/>	<input type="checkbox"/>	<input type="checkbox"/>	<input type="checkbox"/>	<input type="checkbox"/>	<input type="checkbox"/>	<input type="checkbox"/>	<input type="checkbox"/>	<input type="checkbox"/>	<input type="checkbox"/>	<input type="checkbox"/>		
					<input type="checkbox"/> ____ mm	<input type="checkbox"/>	<input type="checkbox"/>	<input type="checkbox"/>	<input type="checkbox"/>	<input type="checkbox"/>	<input type="checkbox"/>	<input type="checkbox"/>	<input type="checkbox"/>	<input type="checkbox"/>	<input type="checkbox"/>	<input type="checkbox"/>	<input type="checkbox"/>		
					<input type="checkbox"/> ____ mm	<input type="checkbox"/>	<input type="checkbox"/>	<input type="checkbox"/>	<input type="checkbox"/>	<input type="checkbox"/>	<input type="checkbox"/>	<input type="checkbox"/>	<input type="checkbox"/>	<input type="checkbox"/>	<input type="checkbox"/>	<input type="checkbox"/>	<input type="checkbox"/>		
					<input type="checkbox"/> ____ mm	<input type="checkbox"/>	<input type="checkbox"/>	<input type="checkbox"/>	<input type="checkbox"/>	<input type="checkbox"/>	<input type="checkbox"/>	<input type="checkbox"/>	<input type="checkbox"/>	<input type="checkbox"/>	<input type="checkbox"/>	<input type="checkbox"/>	<input type="checkbox"/>		
					<input type="checkbox"/> ____ mm	<input type="checkbox"/>	<input type="checkbox"/>	<input type="checkbox"/>	<input type="checkbox"/>	<input type="checkbox"/>	<input type="checkbox"/>	<input type="checkbox"/>	<input type="checkbox"/>	<input type="checkbox"/>	<input type="checkbox"/>	<input type="checkbox"/>	<input type="checkbox"/>		

Bestellformular | Schnellzarge Z135 | Beschläge

Datum	Seite	von	Kommission	Ihre Kundennummer
-------	-------	-----	------------	-------------------

mit Vormontage

- Paket 1 – deutsches Expressband
- Paket 2 – französisches Expressband
- Paket 3 – Expressband ISO
- Paket Easyflex D1 Paket Easyflex D2
- Paket Easyflex CH1 Paket Easyflex CH2
- Paket Easyflex F

ohne Vormontage

- | | |
|--|--|
| <input type="checkbox"/> Kreuzband – deutsch | <input type="checkbox"/> Kreuzband – französisch |
| <input type="checkbox"/> ISO Langband | |
| <input type="checkbox"/> Easyflex-Band D | <input type="checkbox"/> Easyflex-Band CH |
| <input type="checkbox"/> Easyflex-Band F | |
| <input type="checkbox"/> Paket Easyflex D1 | <input type="checkbox"/> Paket Easyflex D2 |
| <input type="checkbox"/> Paket Easyflex CH1 | <input type="checkbox"/> Paket Easyflex CH2 |
| <input type="checkbox"/> Paket Easyflex F | |

- Ladenverschluss & Ladenriegel
- Drehstangenverschluss
- Rechen & Sperrstange
- Schlinggen & Winkelkloben
- Ladenhalter Standard M10
- Ladenhalter Frauenkopf M10
- Vorreiber M10
- Zugwindfalle*
- Windfalle*

* nicht möglich bei Easyflex®

Zusatzinformationen | Schnellzarge Z135

Pos.	Zusatzinformation

EHRET GmbH

Bahnhofstrasse 14-18

D-77972 Mahlberg

Tel. +49(0) 78 22/439-0

Fax +49(0) 78 22/439-116

www.ehret.com

Made in Germany

© 10.2020 EHRET GmbH | F26.D | Technische Änderungen vorbehalten