

Z135 fast frame

Installation frames / Frames



Order form and
planning tool

Stop diagrams

Each view is from the inside!

Deduction clearances are taken into consideration as standard.

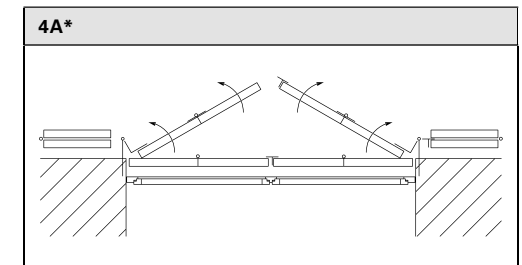
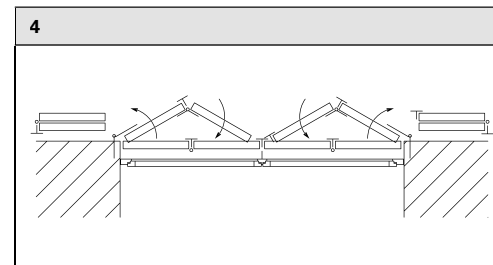
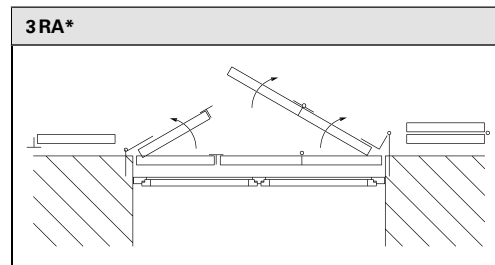
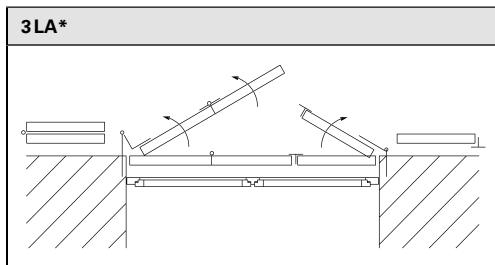
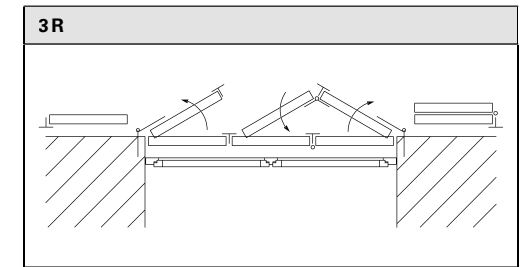
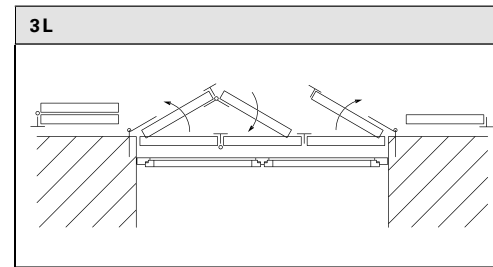
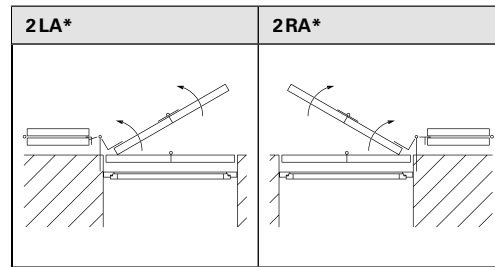
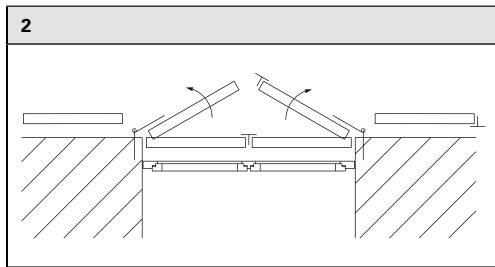
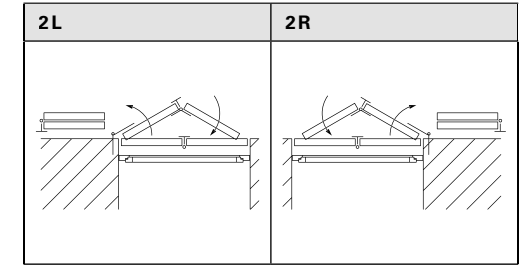
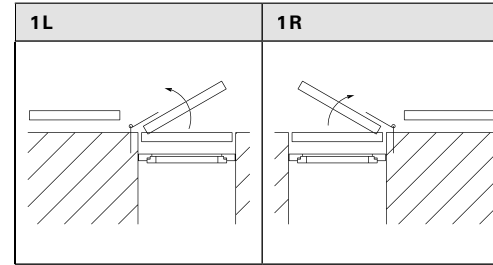

*Diagrams 2LA/RA, 3LA/RA, 4A are not possible with VOLETRONIC option.

Measuring instructions | Z135 fast frame

Measurements | taken with clear width/height and stop diagram

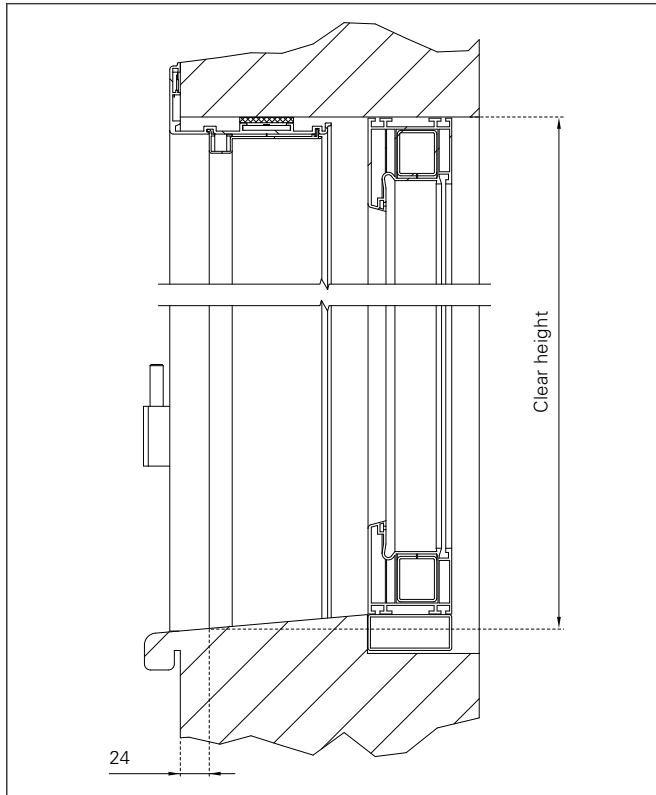

- Window sill angle may need to be adjusted on site.

Deduction clearances (from EHRET)

- Clear width: -10 mm
- Clear height frame 3-sided: -5 mm
- Clear height frame 4-sided: -8 mm

The specified deduction clearances are taken into consideration as standard.

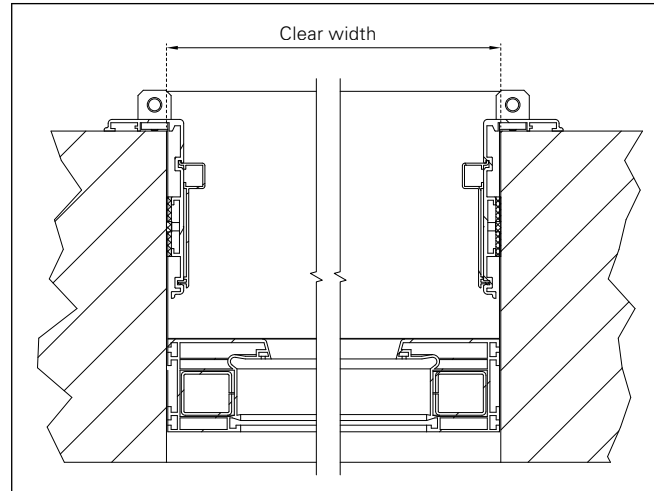

Option | Frame extension (1-120 mm)

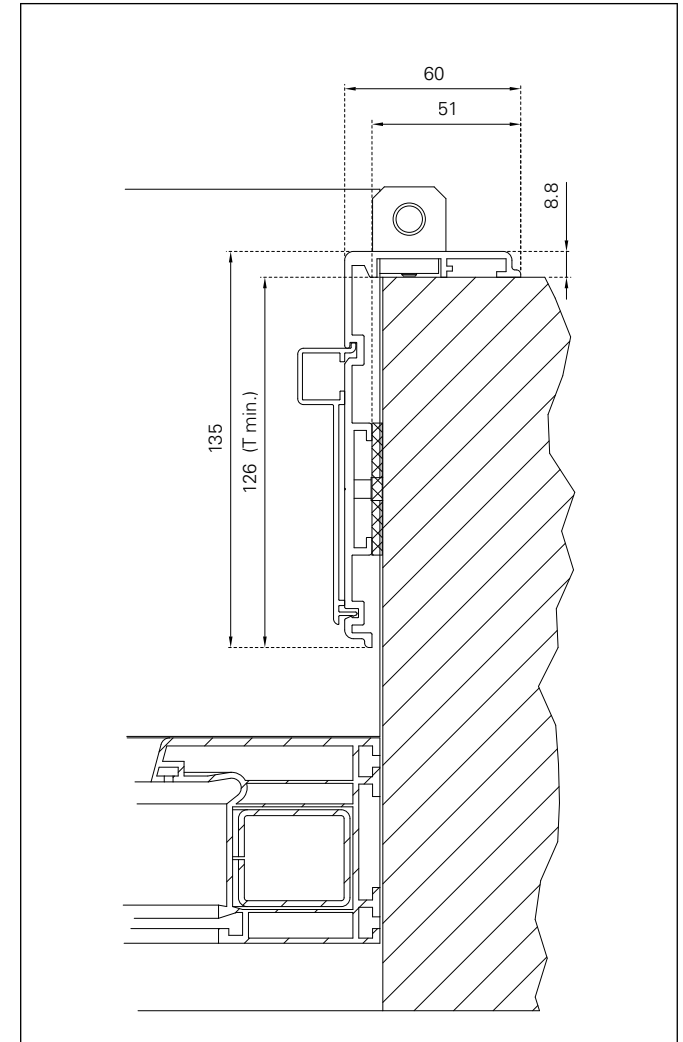
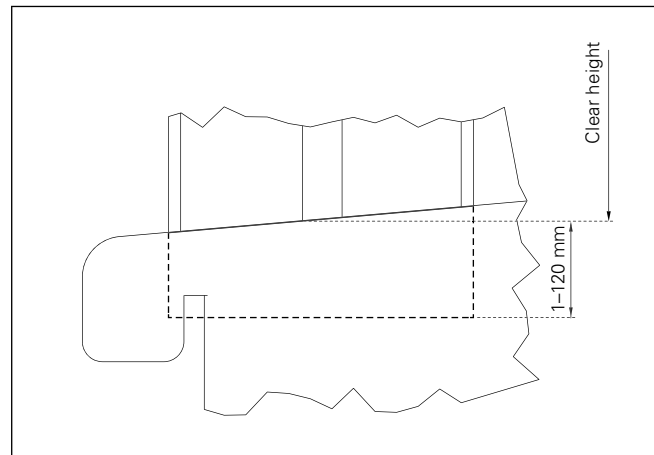

Measuring instructions | Z135 fast frame + VOLETRONIC

Measurements | taken with clear width/height and stop diagram

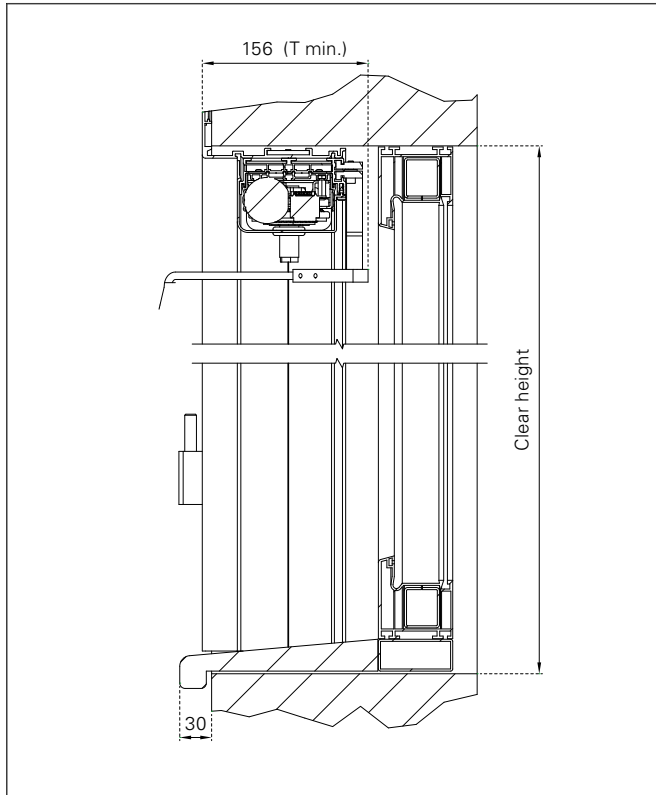

- Window sill angle may need to be adjusted on site.

Deduction clearances (from EHRET)

- Clear width: -10 mm
- Clear height frame 3-sided: -5 mm
- Clear height frame 4-sided: -8 mm

The specified deduction clearances are taken into consideration as standard.

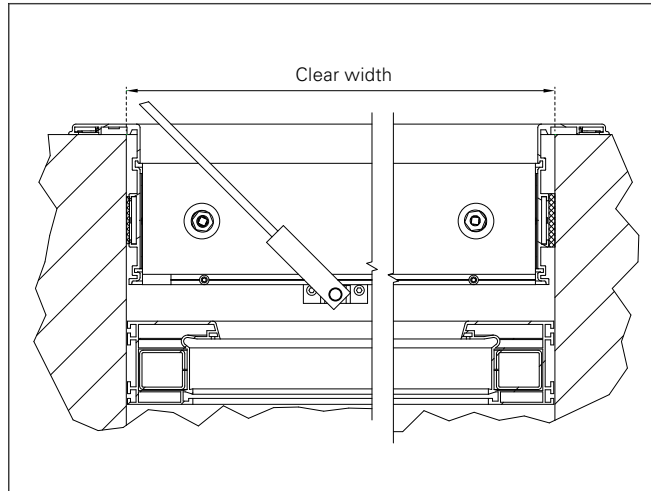

Option | Frame extension (1-120 mm)

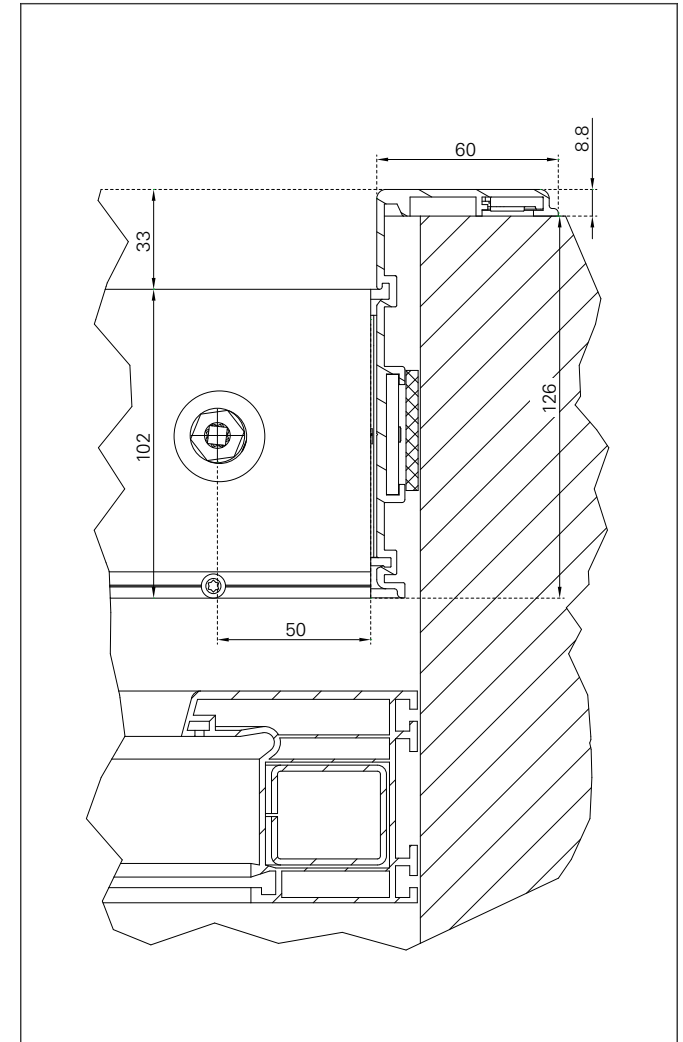
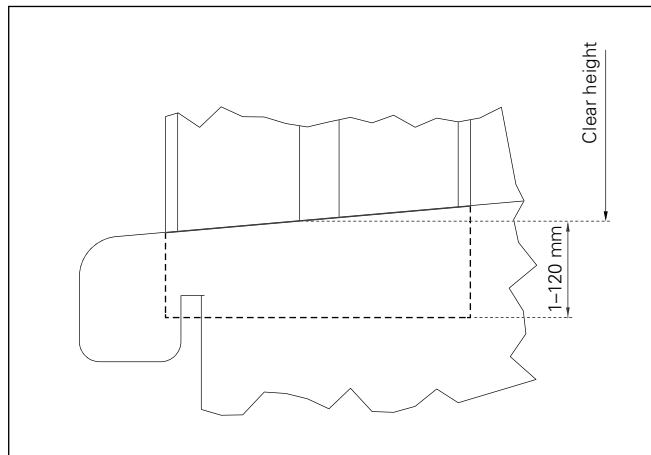

Measuring instructions

Z135 fast frame

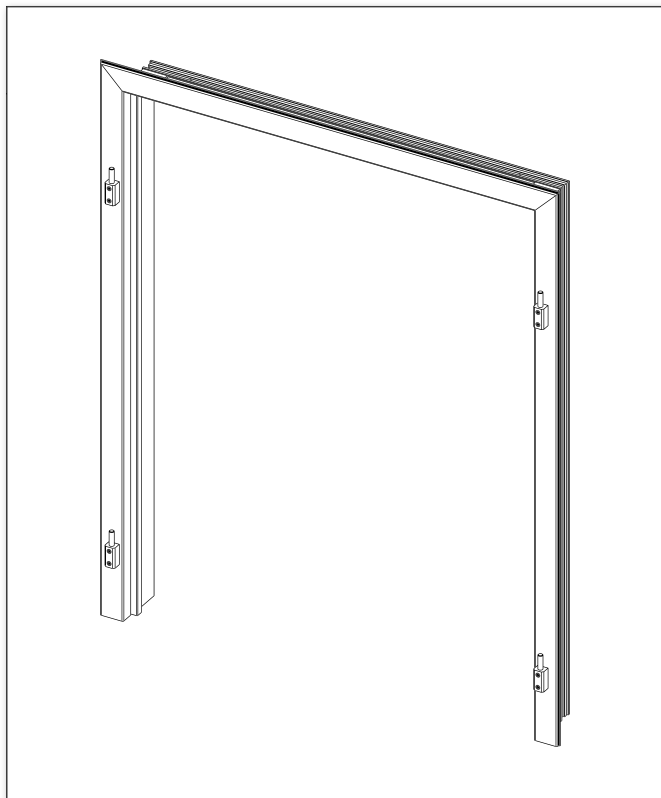

- Dimension T = min. 126 mm

Clear width	Clear height
500–2800 mm	800–2500 mm

Z135 fast frame + VOLETRONIC

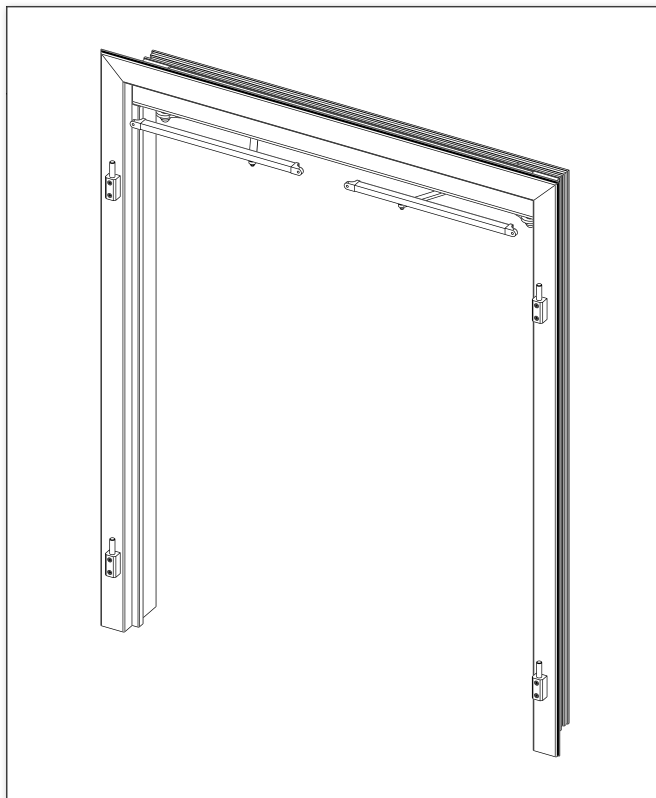

- Dimension T = min. 156 mm

Diagram	Clear width
1R/1L	623 – 840 mm
2R/2L	623 – 1644 mm
2	913 – 1644 mm
3R/3L	913 – 2451 mm
4	1177 – 2530 mm

Pre-installation packages

Paket 1 german

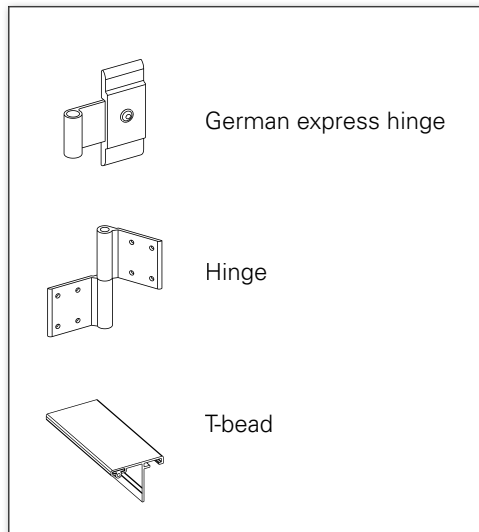

Paket 2 french

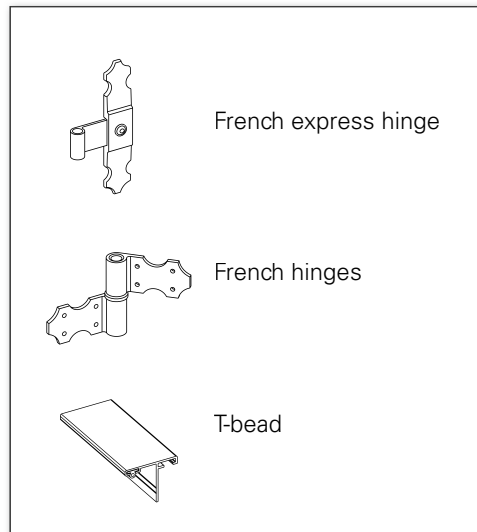



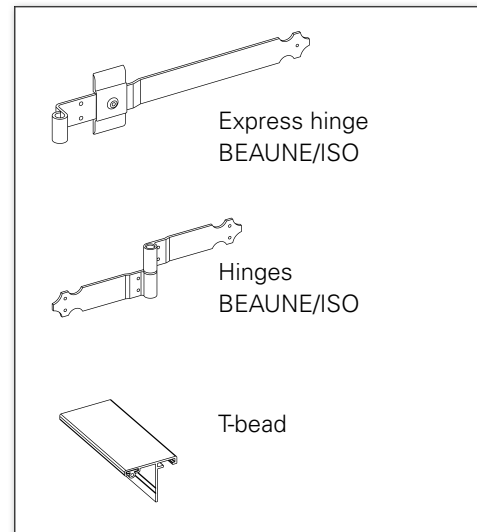





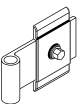
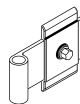
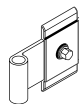
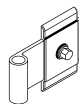
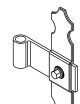
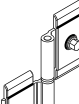
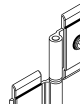
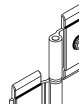
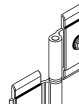
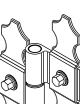
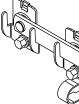
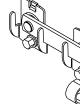
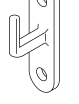
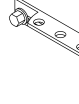
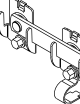

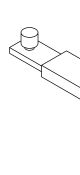
Paket 3 BEAUNE/ISO

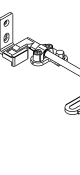

Hardware packages | Easyflex | with/without pre-installation

Easyflex model

Easyflex D1	Easyflex D2	Easyflex CH1	Easyflex CH2	Easyflex F
 <p>Easyflex hinge</p>	 <p>Easyflex hinge</p>	 <p>Easyflex hinge</p>	 <p>Easyflex hinge</p>	 <p>Easyflex F hinge</p>
 <p>Easyflex butterfly hinge</p>	 <p>Easyflex butterfly hinge</p>	 <p>Easyflex butterfly hinge</p>	 <p>Easyflex butterfly hinge</p>	 <p>Easyflex F butterfly hinge</p>
 <p>Easyflex shutter closure*</p>	 <p>Easyflex shutter closure*</p>	 <p>Angle bracket or frame bracket*</p>	 <p>Easyflex shutter rod*</p>	 <p>Easyflex shutter closure*</p>
 <p>Easyflex storm hook* (with plate eye)</p>	 <p>Easyflex shutter lock*</p>	 <p>Easyflex hook coupling*</p>	 <p>Blind rod*</p>	 <p>Easyflex Maco rotating rod closure*</p>
 <p>+ T-bead + Reduction sleeves</p>	 <p>+ T-bead + Reduction sleeves</p>	 <p>+ T-bead + Reduction sleeves</p>	 <p>+ T-bead + Reduction sleeves</p>	 <p>+ T-bead + Pull handle* + Locking bracket*</p>

*Not included in pre-installation package for VOLETRONIC 230 V option

Options | Pre-installation | Add-on lock

R75 frame

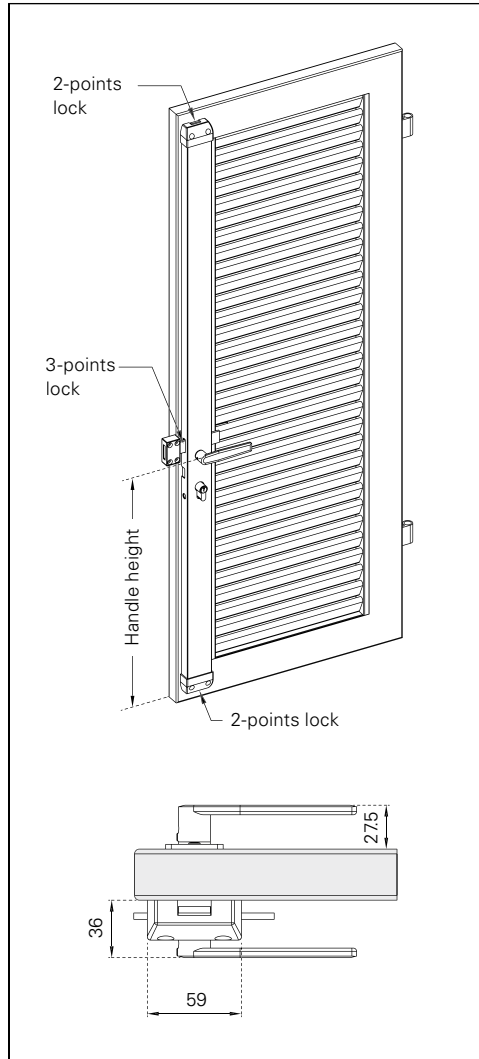

BEAUNE/ISO

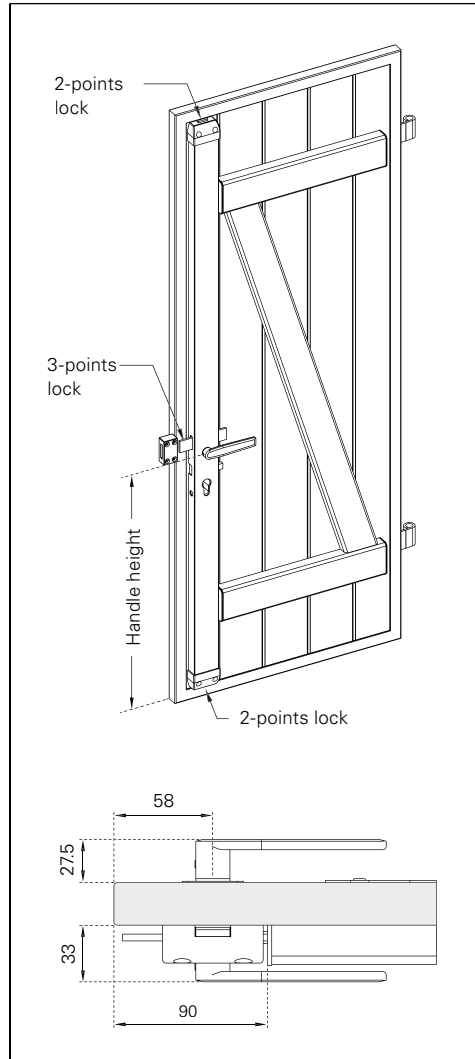

Installation type 3 in rabbet

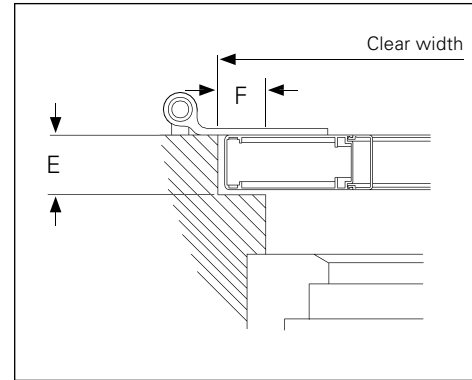

- only with diagram 2, 3L/3R, 3LA/3RA, 4

Order form | Z135 fast frame

Date _____ Page _____ of _____
 Your address and signature _____

Consignment _____

Window shutter model _____

Split with combi models _____

Your customer number _____

Your processor _____

Preferred delivery date _____

Ocean Line plus yes

Pre-installation yes

▶ Please specify hardware/packages on the extra page.

	<input type="checkbox"/> OFFER	<input type="checkbox"/> ORDER	
	Surface	Colour system	Colour n°
Frame*	<input type="checkbox"/> FSM	<input type="checkbox"/> RAL	
	<input type="checkbox"/> Finishes	<input type="checkbox"/> NCS	
	<input type="checkbox"/> Other	<input type="checkbox"/> VSR	
Frame brackets	<input type="checkbox"/> Fittings colour		
Sash*	<input type="checkbox"/> FSM	<input type="checkbox"/> RAL	
	<input type="checkbox"/> Wood finish	<input type="checkbox"/> NCS	
	<input type="checkbox"/> Other	<input type="checkbox"/> VSR	
Fittings	<input type="checkbox"/> FSM	<input type="checkbox"/> RAL	
	<input type="checkbox"/> Other	<input type="checkbox"/> NCS	
		<input type="checkbox"/> VSR	



Tel. +49 (0) 78 22/439-0
 Fax +49 (0) 78 22/439-217
www.ehret.com

Follow-up order
 The original order no. must be specified in the event of follow-up deliveries:

*Frame with drive: Housing in frame colour; bars and guide rails in sash colour, with finish in complementary colour. Please specify variations on the extra page.

Item	Quantity Elements	Stop diagram	Clear dimensions		Frame extension 1-120 mm	VOLETRONIC 230 V							Pre-installation Add-on lock				Miscellaneous	
			Clear width in mm	Clear height in mm		Frame with drive	Cable exit left	Cable exit right	Hand-held trans-mitter 1-channel	Hand-held trans-mitter 5-channel	Hand-held trans-mitter 16-channel	Additional wall trans-mitter	2-points lock	3-points lock	Handle on the outside	with profile cylinder		Handle height
					<input type="checkbox"/> ____ mm	<input type="checkbox"/>	<input type="checkbox"/>	<input type="checkbox"/>	<input type="checkbox"/>	<input type="checkbox"/>	<input type="checkbox"/>	<input type="checkbox"/>	<input type="checkbox"/>	<input type="checkbox"/>	<input type="checkbox"/>	<input type="checkbox"/>	<input type="checkbox"/>	
					<input type="checkbox"/> ____ mm	<input type="checkbox"/>	<input type="checkbox"/>	<input type="checkbox"/>	<input type="checkbox"/>	<input type="checkbox"/>	<input type="checkbox"/>	<input type="checkbox"/>	<input type="checkbox"/>	<input type="checkbox"/>	<input type="checkbox"/>	<input type="checkbox"/>	<input type="checkbox"/>	
					<input type="checkbox"/> ____ mm	<input type="checkbox"/>	<input type="checkbox"/>	<input type="checkbox"/>	<input type="checkbox"/>	<input type="checkbox"/>	<input type="checkbox"/>	<input type="checkbox"/>	<input type="checkbox"/>	<input type="checkbox"/>	<input type="checkbox"/>	<input type="checkbox"/>	<input type="checkbox"/>	
					<input type="checkbox"/> ____ mm	<input type="checkbox"/>	<input type="checkbox"/>	<input type="checkbox"/>	<input type="checkbox"/>	<input type="checkbox"/>	<input type="checkbox"/>	<input type="checkbox"/>	<input type="checkbox"/>	<input type="checkbox"/>	<input type="checkbox"/>	<input type="checkbox"/>	<input type="checkbox"/>	
					<input type="checkbox"/> ____ mm	<input type="checkbox"/>	<input type="checkbox"/>	<input type="checkbox"/>	<input type="checkbox"/>	<input type="checkbox"/>	<input type="checkbox"/>	<input type="checkbox"/>	<input type="checkbox"/>	<input type="checkbox"/>	<input type="checkbox"/>	<input type="checkbox"/>	<input type="checkbox"/>	
					<input type="checkbox"/> ____ mm	<input type="checkbox"/>	<input type="checkbox"/>	<input type="checkbox"/>	<input type="checkbox"/>	<input type="checkbox"/>	<input type="checkbox"/>	<input type="checkbox"/>	<input type="checkbox"/>	<input type="checkbox"/>	<input type="checkbox"/>	<input type="checkbox"/>	<input type="checkbox"/>	
					<input type="checkbox"/> ____ mm	<input type="checkbox"/>	<input type="checkbox"/>	<input type="checkbox"/>	<input type="checkbox"/>	<input type="checkbox"/>	<input type="checkbox"/>	<input type="checkbox"/>	<input type="checkbox"/>	<input type="checkbox"/>	<input type="checkbox"/>	<input type="checkbox"/>	<input type="checkbox"/>	
					<input type="checkbox"/> ____ mm	<input type="checkbox"/>	<input type="checkbox"/>	<input type="checkbox"/>	<input type="checkbox"/>	<input type="checkbox"/>	<input type="checkbox"/>	<input type="checkbox"/>	<input type="checkbox"/>	<input type="checkbox"/>	<input type="checkbox"/>	<input type="checkbox"/>	<input type="checkbox"/>	
					<input type="checkbox"/> ____ mm	<input type="checkbox"/>	<input type="checkbox"/>	<input type="checkbox"/>	<input type="checkbox"/>	<input type="checkbox"/>	<input type="checkbox"/>	<input type="checkbox"/>	<input type="checkbox"/>	<input type="checkbox"/>	<input type="checkbox"/>	<input type="checkbox"/>	<input type="checkbox"/>	
					<input type="checkbox"/> ____ mm	<input type="checkbox"/>	<input type="checkbox"/>	<input type="checkbox"/>	<input type="checkbox"/>	<input type="checkbox"/>	<input type="checkbox"/>	<input type="checkbox"/>	<input type="checkbox"/>	<input type="checkbox"/>	<input type="checkbox"/>	<input type="checkbox"/>	<input type="checkbox"/>	

Order form | **Z135 fast frame** | Hardware

Date _____ Page _____ of _____ Consignment _____ Your customer number _____

With pre-installation

- Package 1 – German express hinge
- Package 2 – French express hinge
- Package 3 – ISO express hinge
- Easyflex package D1 Easyflex package D2
- Easyflex package CH1 Easyflex package CH2
- Easyflex package F

Without pre-installation

- Cross hinge – German Cross hinge – French
- ISO long hinge
- Easyflex hinge D Easyflex hinge CH
- Easyflex hinge F
- Easyflex package D1 Easyflex package D2
- Easyflex package CH1 Easyflex package CH2
- Easyflex package F

- Shutter closure & shutter lock
- Espagnolette
- Rod & lock bar
- Hook & angle bracket
- Shutter holder, standard M10
- Shutter holder, lady head M10
- Sash lock M10
- Pull catch*
- Catch*

*not possible with Easyflex®

Additional information | Z135 fast frame

Item	Additional information

EHRET GmbH

Bahnhofstrasse 14-18

D-77972 Mahlberg

Tel. +49(0) 78 22/439-0

Fax +49(0) 78 22/439-116

www.ehret.com

Made in Germany

© 06.2021 EHRET GmbH | F26.E | Subject to technical modifications