

## Intelaiatura rapida Z135

Telai di montaggio / intelaiature



Moduli di ordinazione  
e scheda tecnica

# Schemi di posa

Le viste sono dall'interno!

Consideriamo le quote di deduzione quote standard.

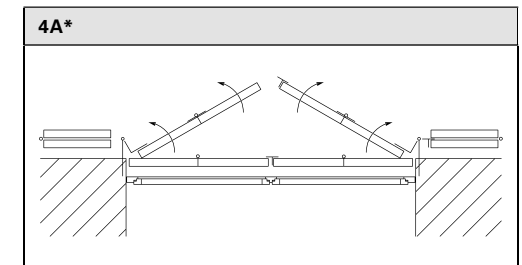
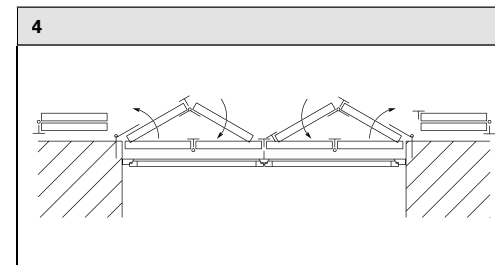
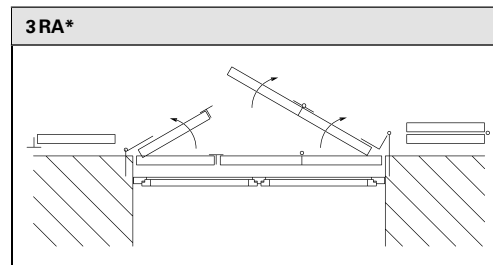
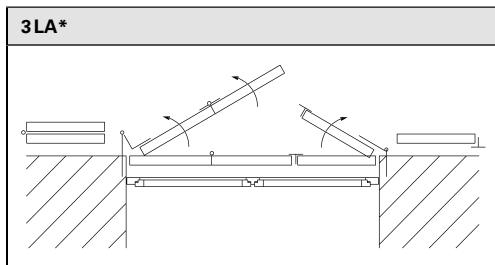
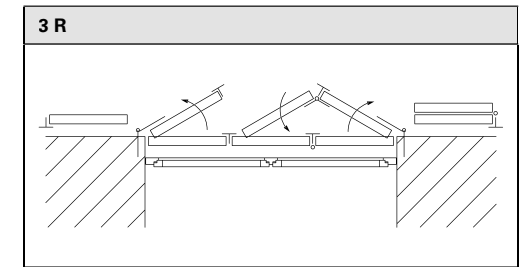
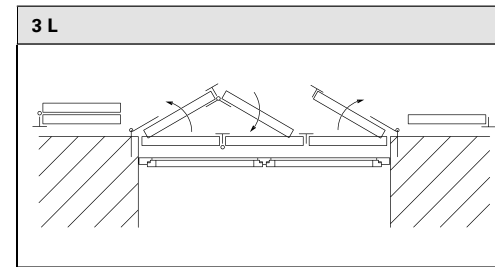
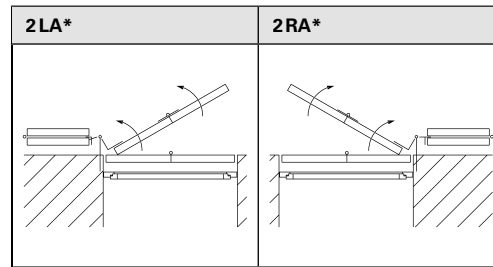
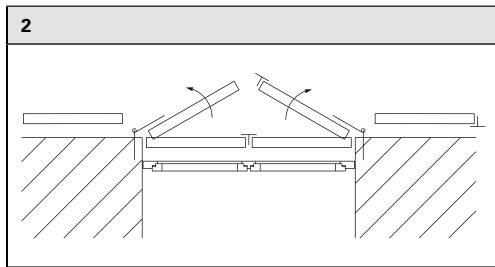
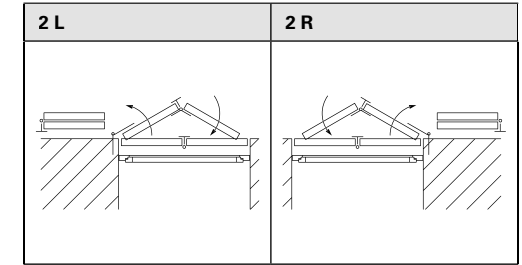
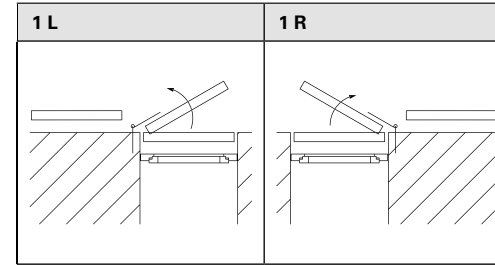

\*Schemi 2LA/RA, 3LA/RA, 4A impossibili da realizzare con l'opzione VOLETRONIC!

# Istruzioni di misurazione | Intelaiatura rapida Z135

Rilevamento della misura | con larghezza/altezza libera e schema di posa

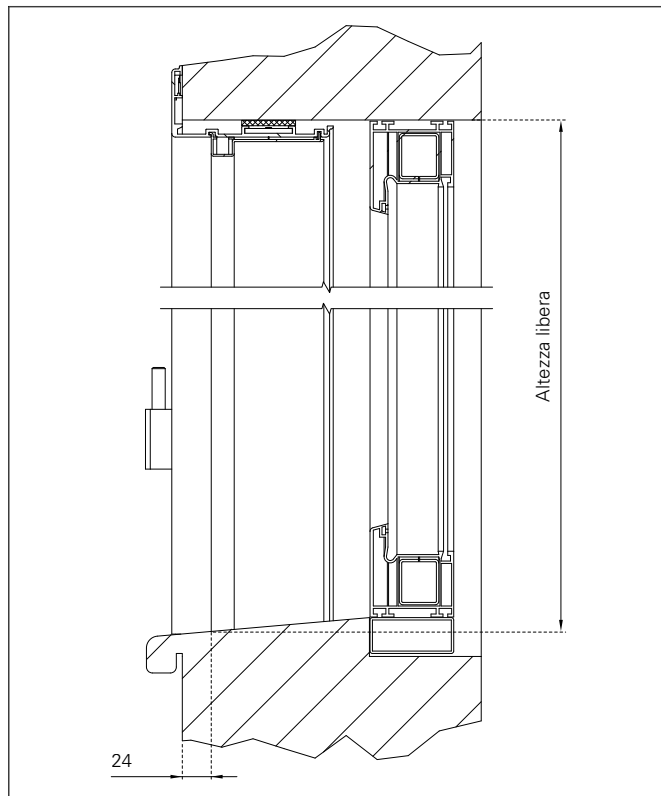

- L'inclinazione del davanzale interno deve eventualmente essere adattata dal cliente!

## Quote di deduzione EHRET

- Larghezza libera: -10 mm
- Altezza libera 3 lati: -5 mm
- Altezza libera 4 lati: -8 mm

Le quote di deduzione indicate sono considerate standard

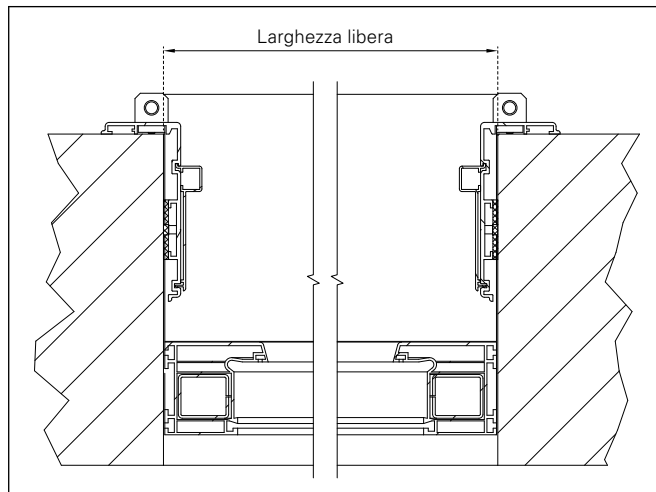

## Opzione | Prolunga intelaiatura (1-120 mm)

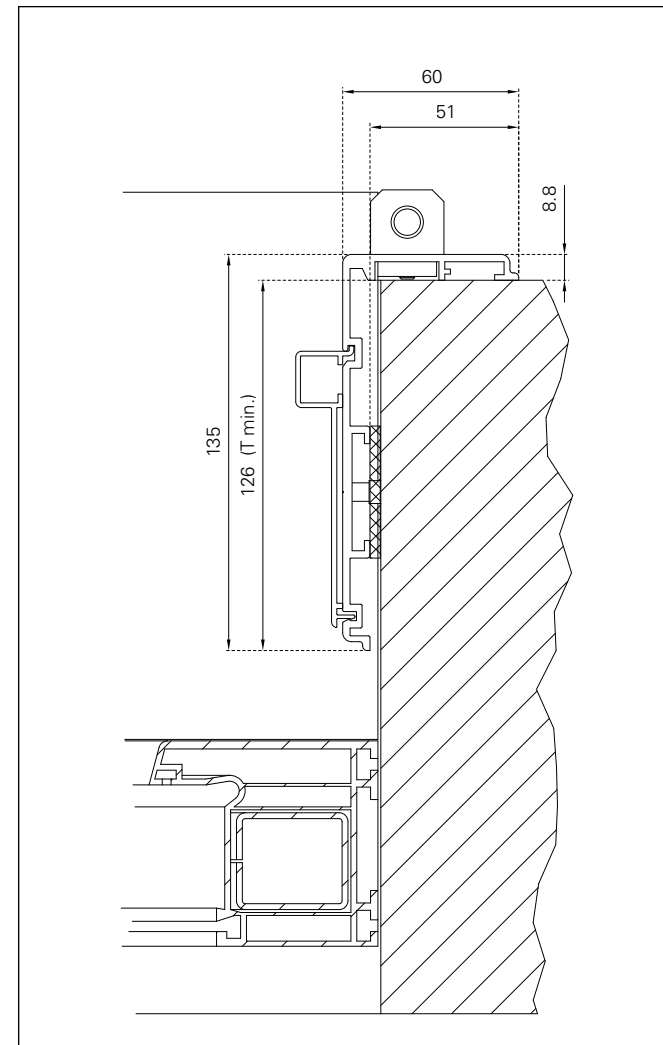
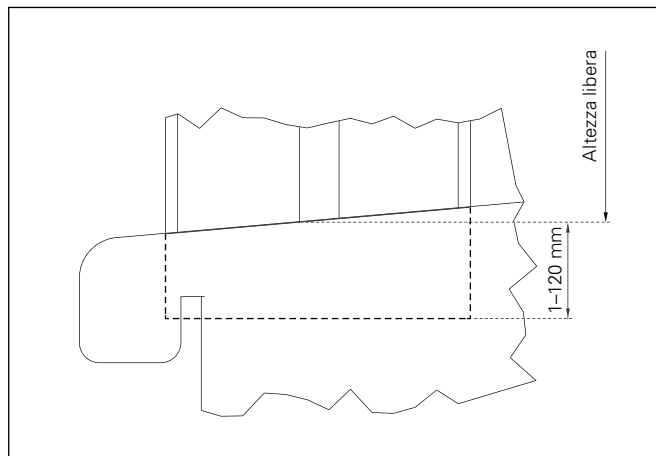

# Istruzioni di misurazione | Intelaiatura rapida Z135 + VOLETRONIC

Rilevamento della misura | con larghezza/altezza libera e schema di posa

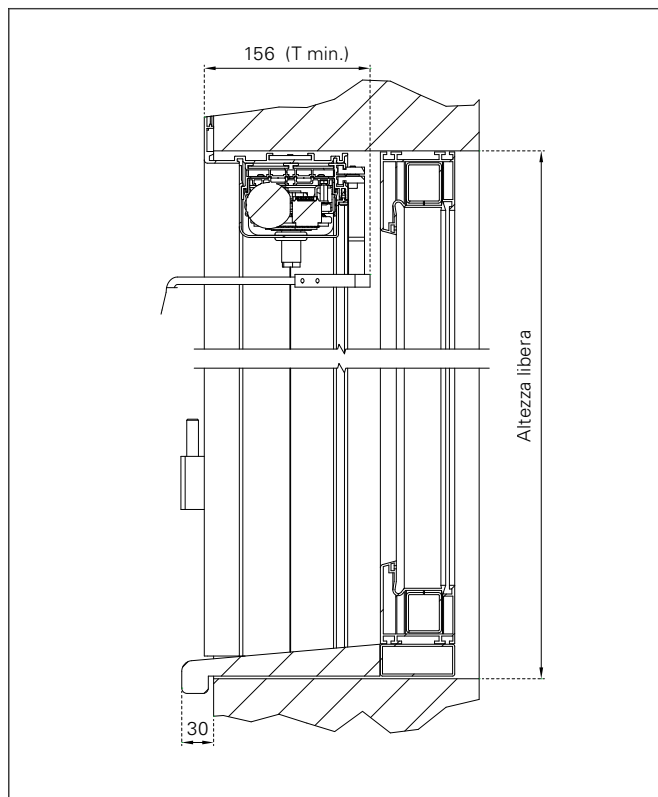

- L'inclinazione del davanzale interno deve eventualmente essere adattata dal cliente!

## Quote di deduzione EHRET

- Larghezza libera: -10 mm
- Altezza libera 3 lati: -5 mm
- Altezza libera 4 lati: -8 mm

Le quote di deduzione indicate sono considerate standard

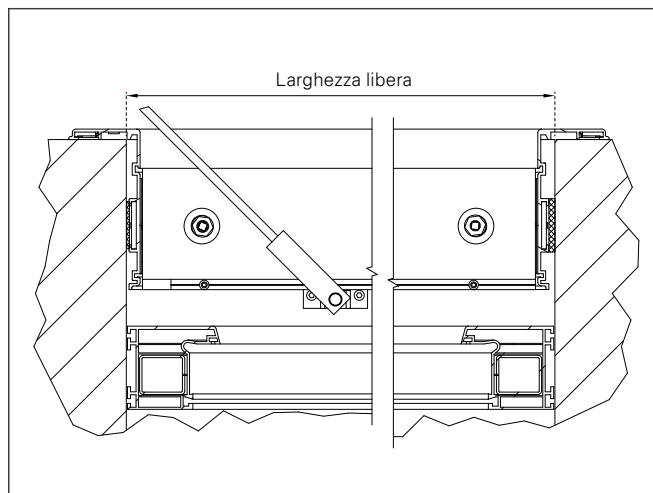

## Opzione | Prolunga intelaiatura (1-120 mm)

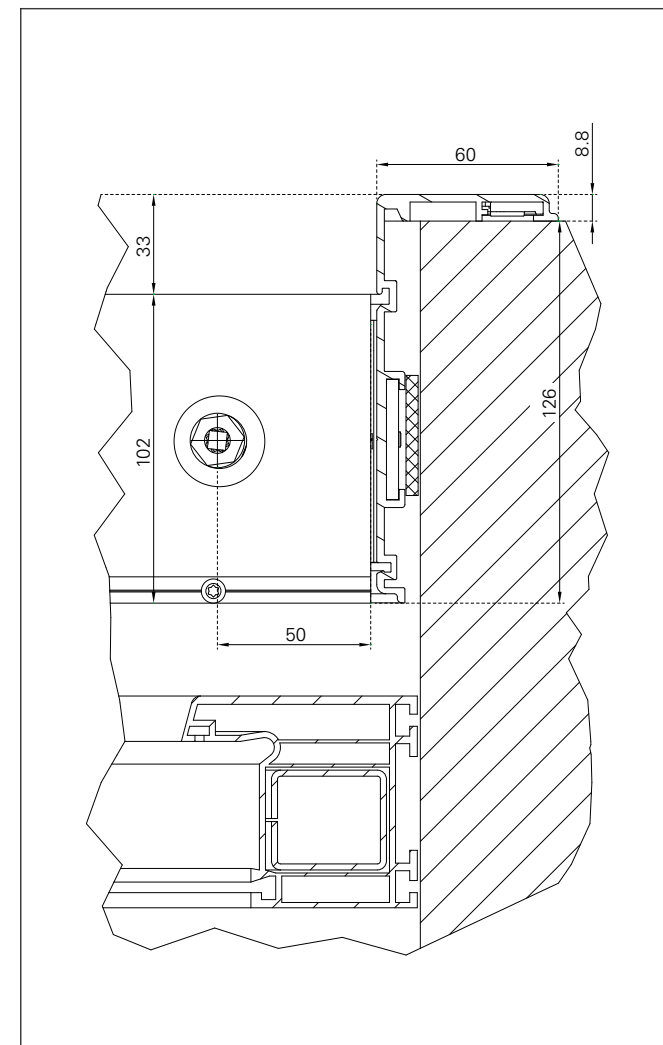
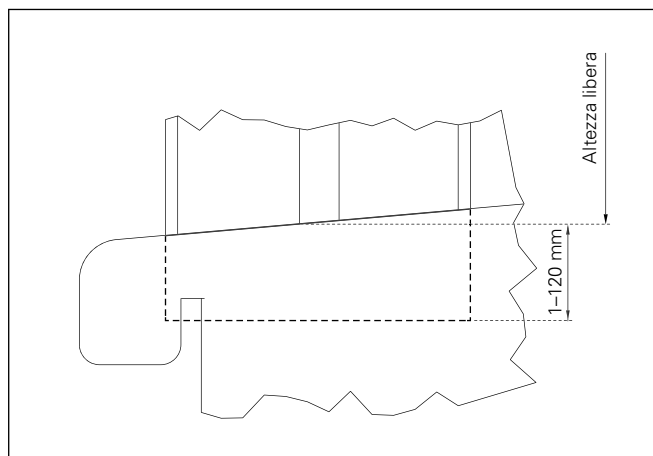

# Istruzioni di misurazione

Intelaiatura rapida Z135

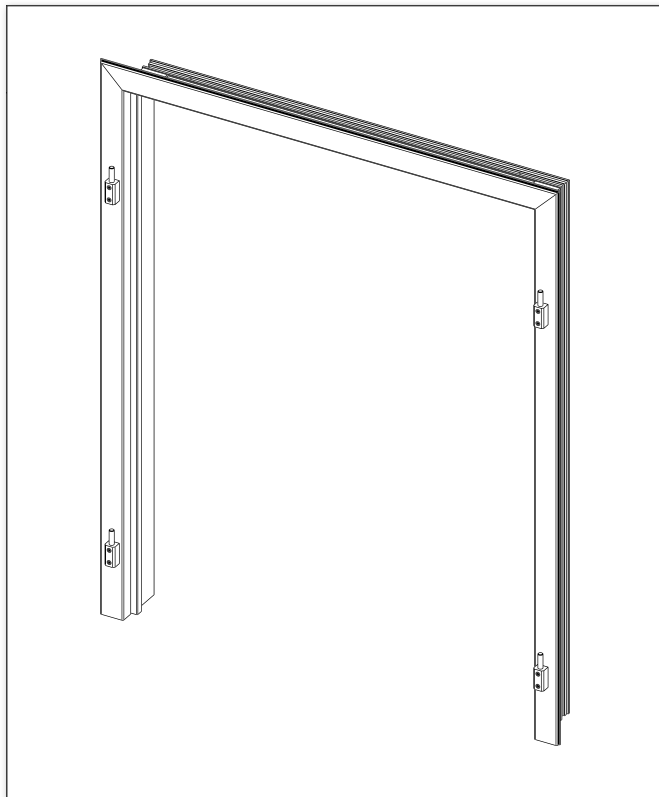

- Quota T = min. 126 mm

Larghezza libera	Altezza libera
500 – 2800 mm	800 – 2500 mm

Intelaiatura rapida Z135 + VOLETRONIC

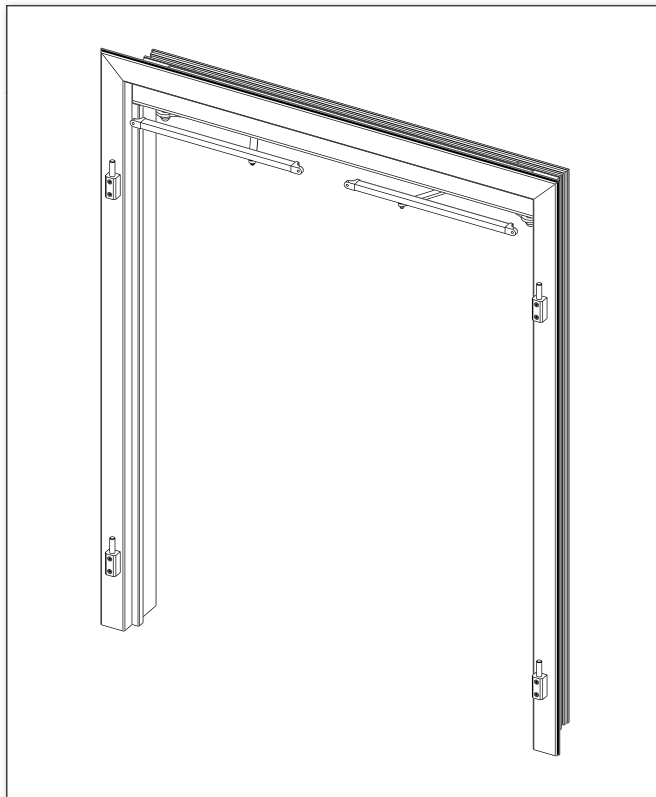

- Quota T = min. 156 mm

Schema	Larghezza libera
1R/1L	623 – 840 mm
2R/2L	623 – 1644 mm
2	913 – 1644 mm
3R/3L	913 – 2451 mm
4	1177 – 2530 mm

# Set di premontaggio

Set 1 tedesca

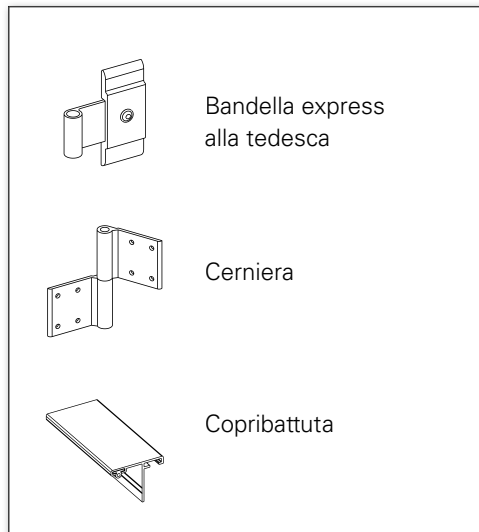

Paket 2 francese

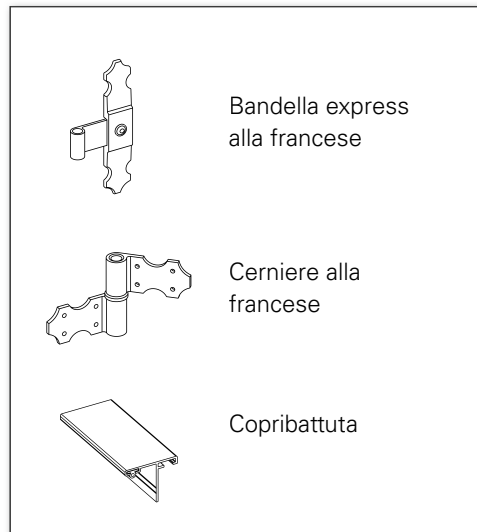

Paket 3 BEAUNE/ISO

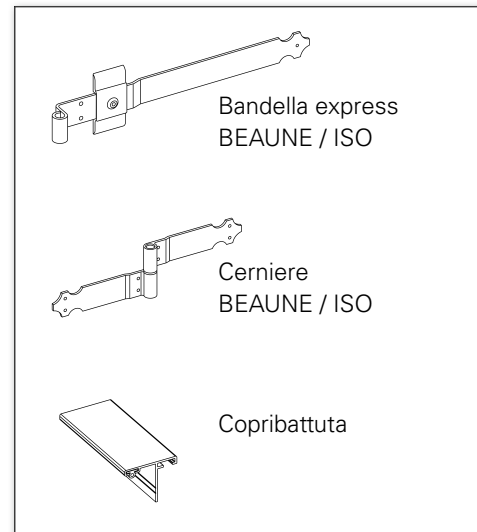

# Pacchetti ferramenta | Easyflex | con/senza montaggio preliminare

## Modelli Easyflex

### Easyflex D1

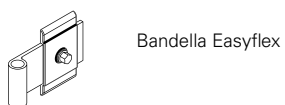

Bandella Easyflex

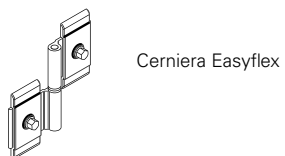

Cerniera Easyflex



Chiusura persiana Easyflex\*



Gancio antivento Easyflex\*  
(con occhiello piastra)

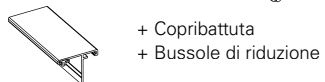

+ Copribattuta  
+ Bussole di riduzione

### Easyflex D2

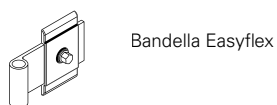

Bandella Easyflex

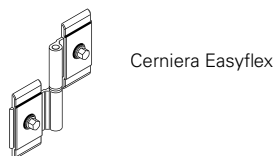

Cerniera Easyflex



Chiusura persiana Easyflex\*

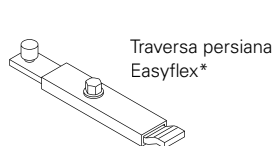

Traversa persiana Easyflex\*

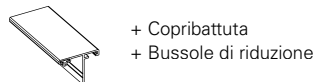

+ Copribattuta  
+ Bussole di riduzione

### Easyflex CH1

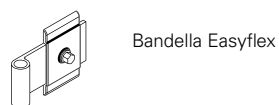

Bandella Easyflex

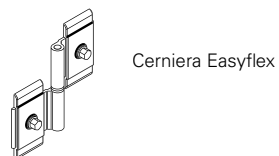

Cerniera Easyflex



Archetto angolare o  
di chiusura\*

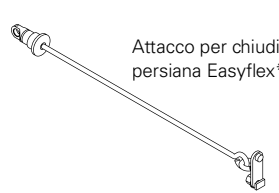

Attacco per chiudi-  
persiana Easyflex\*

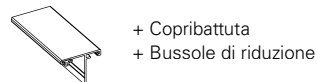

+ Copribattuta  
+ Bussole di riduzione

### Easyflex CH2



Bandella Easyflex

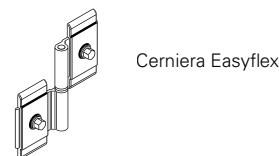

Cerniera Easyflex



Rastrelliera persiana  
Easyflex\*

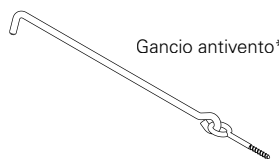

Gancio antivento\*

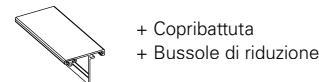

+ Copribattuta  
+ Bussole di riduzione

### Easyflex F

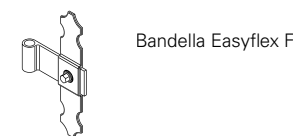

Bandella Easyflex F



Cerniera  
Easyflex F



Chiusura persiana  
Easyflex\*

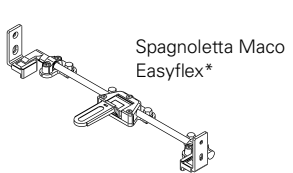

Spagnoletta Maco  
Easyflex\*

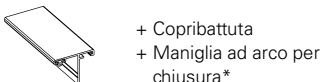

+ Copribattuta  
+ Maniglia ad arco per  
chiusura\*  
+ Squadra di bloccaggio\*

\*non contenuti nel pacchetto di montaggio preliminare con l'opzione VOLETRONIC!

# Opzioni | Montaggio preliminare | Serratura sovrapposta

Telaio R75

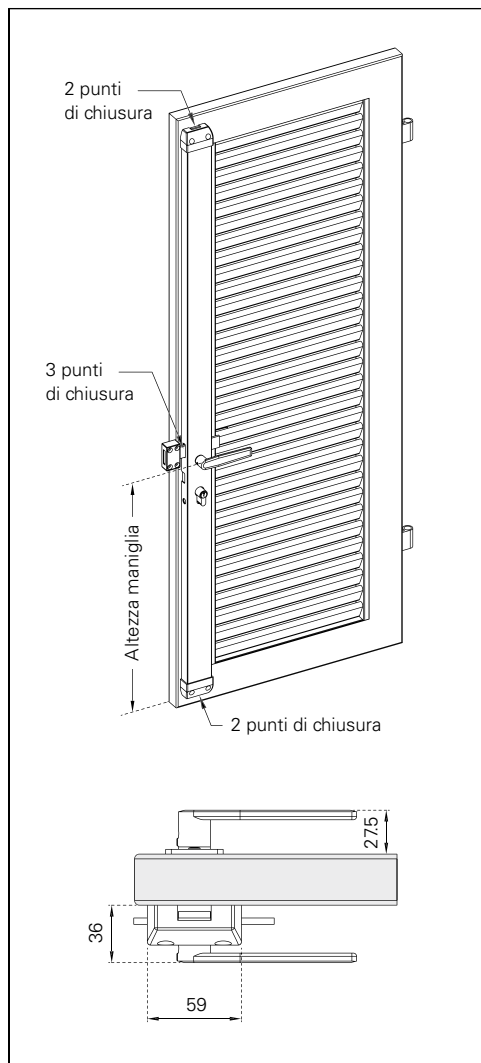

BEAUNE/ISO

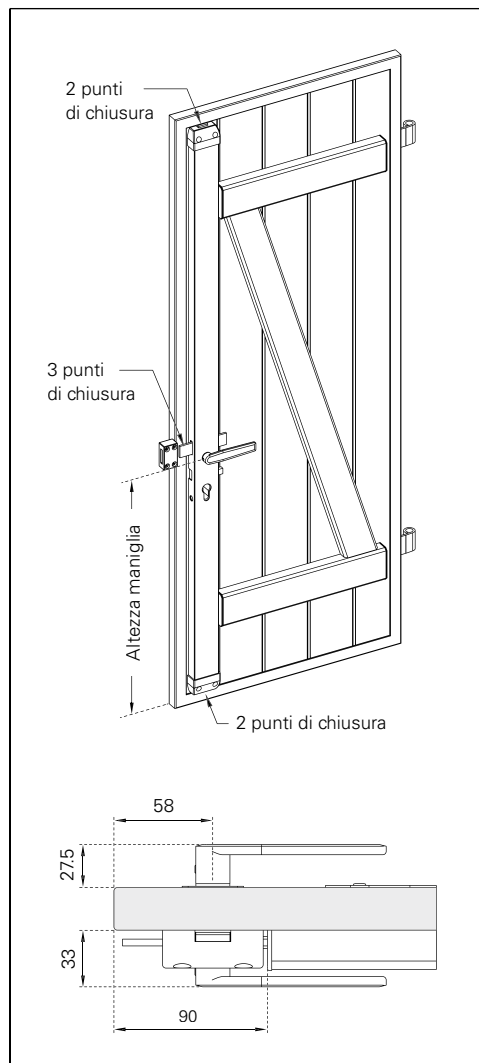

Tipo di montaggio 3 nella battentatura

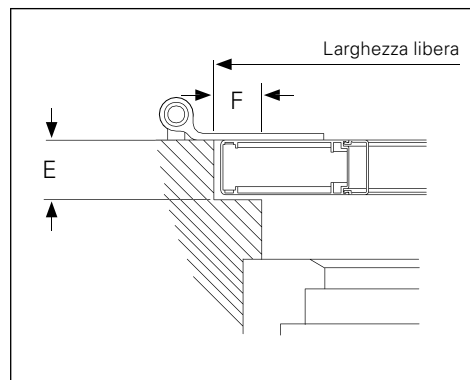

• solo con schemi 2, 3L/3R, 3LA/3RA, 4



# Modulo di ordinazione | Intelaiatura rapida Z135

Data _____	pagina _____	di _____	Commissione _____
Indirizzo e firma _____			Modello di persiana a battenti _____
Codice cliente _____			Suddivisione per modelli combinati _____
Addetto _____			Ocean Line plus <input type="checkbox"/> sì
Termine di consegna desiderato _____			Montaggio preliminare <input type="checkbox"/> sì

► Si prega di inserire le ferramenta / i pacchetti di ferramenta nella pagina apposita.

	<input type="checkbox"/> OFFERTA	<input type="checkbox"/> ORDINE	
	<i>Superficie</i>	<i>Sistema colori</i>	<i>Codice</i>
Intelaiatura*	<input type="checkbox"/> FSM**	<input type="checkbox"/> RAL	
	<input type="checkbox"/> Decorazione	<input type="checkbox"/> NCS	
	<input type="checkbox"/> Varie	<input type="checkbox"/> VSR	
Ante*	<input type="checkbox"/> FSM**	<input type="checkbox"/> RAL	
	<input type="checkbox"/> Decor. legno	<input type="checkbox"/> NCS	
	<input type="checkbox"/> Varie	<input type="checkbox"/> VSR	
Ferramenta	<input type="checkbox"/> FSM**	<input type="checkbox"/> RAL	
	<input type="checkbox"/> Varie	<input type="checkbox"/> NCS	
		<input type="checkbox"/> VSR	

\*\*struttura fine e opaca

\*con azionamento: alloggiamento in tinta con l'intelaiatura; staffa e binari di guida in tinta con le ante, decorazioni in colore complementare. Si prega di inserire le divergenze nella pagina apposita.

# EHRET

Tel. +49(0)78 22/439-0  
 Fax +49(0)78 22/439-217  
[www.ehret.com](http://www.ehret.com)

**Ordinazione successiva**

in caso di forniture successive indicare assolutamente il n. ordine originario:

--

Pos.	Numero di elementi	Schema di posa	Quote libere		Prolunga intelaiatura 1-120 mm	VOLETRONIC 230V								Montaggio preliminare Serratura sovrapposta				Altezza maniglia	Varie	
			Larghezza libera	Altezza libera		Intelaiatura con azionamento	Uscita cavo a sinistra	Uscita cavo a destra	Trasmitt. manuale a 1 canale	Trasmitt. manuale a 5 canale	Trasmitt. manuale a 16 canale	Trasmitt. a parete aggiuntivo	2 punti di chiusura	3 punti di chiusura	maniglia esterna	con cilindro profilato Euro				
					<input type="checkbox"/> ____ mm	<input type="checkbox"/>	<input type="checkbox"/>	<input type="checkbox"/>	<input type="checkbox"/>	<input type="checkbox"/>	<input type="checkbox"/>	<input type="checkbox"/>	<input type="checkbox"/>	<input type="checkbox"/>	<input type="checkbox"/>	<input type="checkbox"/>	<input type="checkbox"/>	<input type="checkbox"/>		
					<input type="checkbox"/> ____ mm	<input type="checkbox"/>	<input type="checkbox"/>	<input type="checkbox"/>	<input type="checkbox"/>	<input type="checkbox"/>	<input type="checkbox"/>	<input type="checkbox"/>	<input type="checkbox"/>	<input type="checkbox"/>	<input type="checkbox"/>	<input type="checkbox"/>	<input type="checkbox"/>	<input type="checkbox"/>		
					<input type="checkbox"/> ____ mm	<input type="checkbox"/>	<input type="checkbox"/>	<input type="checkbox"/>	<input type="checkbox"/>	<input type="checkbox"/>	<input type="checkbox"/>	<input type="checkbox"/>	<input type="checkbox"/>	<input type="checkbox"/>	<input type="checkbox"/>	<input type="checkbox"/>	<input type="checkbox"/>	<input type="checkbox"/>		
					<input type="checkbox"/> ____ mm	<input type="checkbox"/>	<input type="checkbox"/>	<input type="checkbox"/>	<input type="checkbox"/>	<input type="checkbox"/>	<input type="checkbox"/>	<input type="checkbox"/>	<input type="checkbox"/>	<input type="checkbox"/>	<input type="checkbox"/>	<input type="checkbox"/>	<input type="checkbox"/>	<input type="checkbox"/>		
					<input type="checkbox"/> ____ mm	<input type="checkbox"/>	<input type="checkbox"/>	<input type="checkbox"/>	<input type="checkbox"/>	<input type="checkbox"/>	<input type="checkbox"/>	<input type="checkbox"/>	<input type="checkbox"/>	<input type="checkbox"/>	<input type="checkbox"/>	<input type="checkbox"/>	<input type="checkbox"/>	<input type="checkbox"/>		
					<input type="checkbox"/> ____ mm	<input type="checkbox"/>	<input type="checkbox"/>	<input type="checkbox"/>	<input type="checkbox"/>	<input type="checkbox"/>	<input type="checkbox"/>	<input type="checkbox"/>	<input type="checkbox"/>	<input type="checkbox"/>	<input type="checkbox"/>	<input type="checkbox"/>	<input type="checkbox"/>	<input type="checkbox"/>		
					<input type="checkbox"/> ____ mm	<input type="checkbox"/>	<input type="checkbox"/>	<input type="checkbox"/>	<input type="checkbox"/>	<input type="checkbox"/>	<input type="checkbox"/>	<input type="checkbox"/>	<input type="checkbox"/>	<input type="checkbox"/>	<input type="checkbox"/>	<input type="checkbox"/>	<input type="checkbox"/>	<input type="checkbox"/>		
					<input type="checkbox"/> ____ mm	<input type="checkbox"/>	<input type="checkbox"/>	<input type="checkbox"/>	<input type="checkbox"/>	<input type="checkbox"/>	<input type="checkbox"/>	<input type="checkbox"/>	<input type="checkbox"/>	<input type="checkbox"/>	<input type="checkbox"/>	<input type="checkbox"/>	<input type="checkbox"/>	<input type="checkbox"/>		
					<input type="checkbox"/> ____ mm	<input type="checkbox"/>	<input type="checkbox"/>	<input type="checkbox"/>	<input type="checkbox"/>	<input type="checkbox"/>	<input type="checkbox"/>	<input type="checkbox"/>	<input type="checkbox"/>	<input type="checkbox"/>	<input type="checkbox"/>	<input type="checkbox"/>	<input type="checkbox"/>	<input type="checkbox"/>		
					<input type="checkbox"/> ____ mm	<input type="checkbox"/>	<input type="checkbox"/>	<input type="checkbox"/>	<input type="checkbox"/>	<input type="checkbox"/>	<input type="checkbox"/>	<input type="checkbox"/>	<input type="checkbox"/>	<input type="checkbox"/>	<input type="checkbox"/>	<input type="checkbox"/>	<input type="checkbox"/>	<input type="checkbox"/>		



**EHRET GmbH**

Bahnhofstrasse 14-18

D-77972 Mahlberg

Tel. +49(0) 78 22/439-0

Fax +49(0) 78 22/439-116

[www.ehret.com](http://www.ehret.com)

Made in Germany

© 10.2020 EHRET GmbH | F26.I | Con riserva di modifiche tecniche