

PERSIENNE

Aluminium folding shutters



Order form and
planning tool

Stop diagrams

The stop diagrams are sketched as if viewed from inside.
The term 5L-3R stands for 5 sashes left (L) and 3 sashes right (R).

on one side

example: 5L

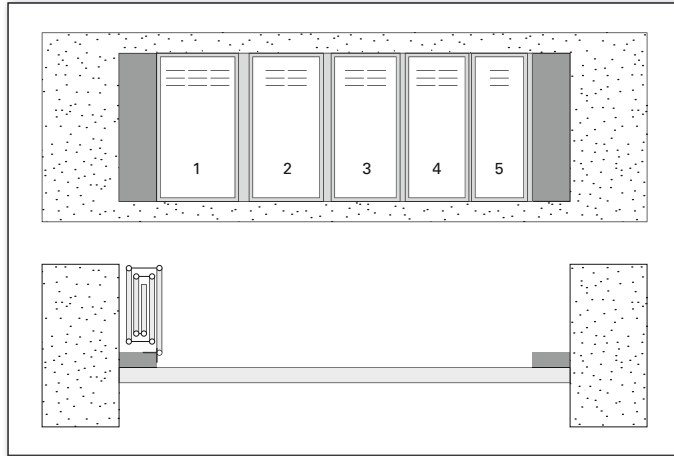

on both sides

example: 3L-3R

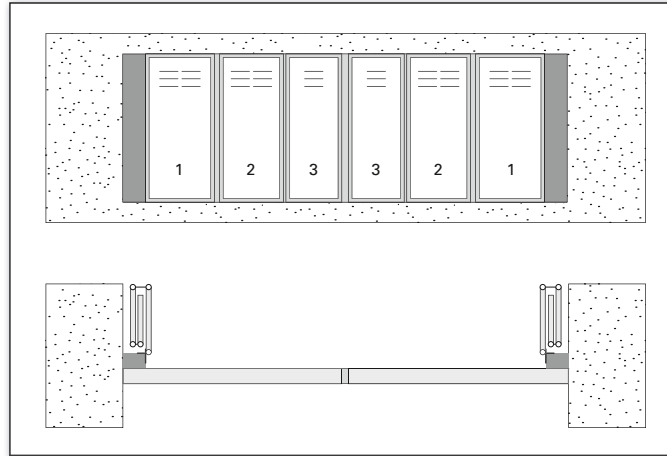

asymmetrical

example: 2L-3R

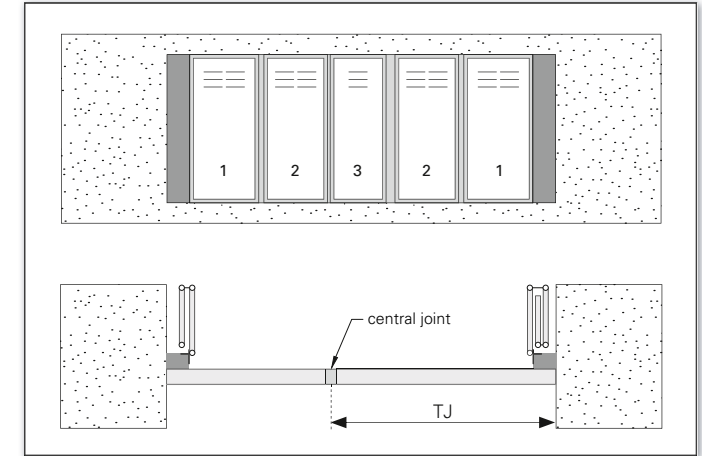

- TJ = width approx. from right reveal (viewed from inside) up to central joint
(Embrasure droite jusqu'à la jonction centrale)

Maximum dimensions

Diagram	Width min. between connection profiles	Width max. between connection profiles	reveal depth min. from connection profile to masonry	Min. connection profile dimensions
---------	--	--	--	------------------------------------

2L, 2R	372 / 252*	762	196	50 × 30 × 2
3L, 3R	632	1157	216	60 × 30 × 2
4L, 4R	932	1400	236	80 × 30 × 2
5L, 5R	1272	1397	256	100 × 30 × 2

*with compensation slat

Diagram	Width min. between connection profiles	Width max. between connection profiles	reveal depth min. from connection profile to masonry	Min. connection profile dimensions
---------	--	--	--	------------------------------------

2L-2R	734 / 494*	1514	196	50 × 30 × 2
3L-3R	1254	2304	216	60 × 30 × 2
4L-4R	1854	2790	236	80 × 30 × 2
5L-5R	2534	2784	256	100 × 30 × 2

*with compensation slat

Diagram	Width min. between connection profiles	Width max. between connection profiles	reveal depth min. from connection profile to masonry	Min. connection profile dimensions
---------	--	--	--	------------------------------------

2L-1R, 1L-2R	534 / 414*	1149	196	50 × 30 × 2
3L-1R, 1L-3R	794	1544	216	60 × 30 × 2
4L-1R, 1L-4R	1094	2162	236	80 × 30 × 2
5L-1R, 1L-5R	1434	1784	256	100 × 30 × 2
3L-2R, 2L-3R	994	1909	216	60 × 30 × 2
4L-2R, 2L-4R	1294	2152	236	80 × 30 × 2
5L-2R, 2L-5R	1634	2159	256	100 × 30 × 2
4L-3R, 3L-4R	1554	2547	236	80 × 30 × 2
5L-3R, 3L-5R	1894	2544	256	100 × 30 × 2
5L-4R, 4L-5R	2194	2787	256	100 × 30 × 2

*with compensation slat

Measuring instructions

Installation type 1 | Connection profile on the reveal

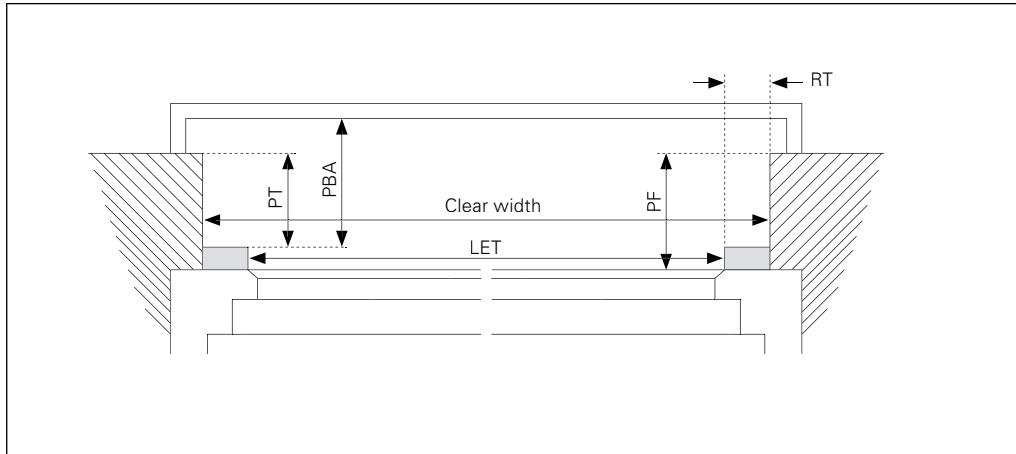

- LET = width between connection profiles (*Largeur Entre Tapées*)
- PT = reveal depth from connection profile to masonry (*Profondeur Tableau*)
- PBA = depth from connection profile to balcony (*Profondeur Barre Appui*)
- RT = visible width of connection profile (*Retombée de Tapée*)
- PF = reveal depth from window to masonry (*Profondeur Fenêtre*)

Option connection profile

Aluminum rectangular tube:

- at the side: 50/60/80/100 × 30 × 2 mm
- at the top and bottom: 20/40/50/60/80/100 × 30 × 2 mm

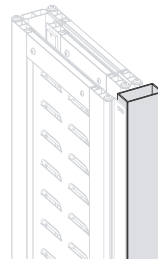

INFO

- Visible width of connection profile depending on stop diagram! (see table 'Maximum dimensions')

Installation type 2 | Connection profile inset in the masonry

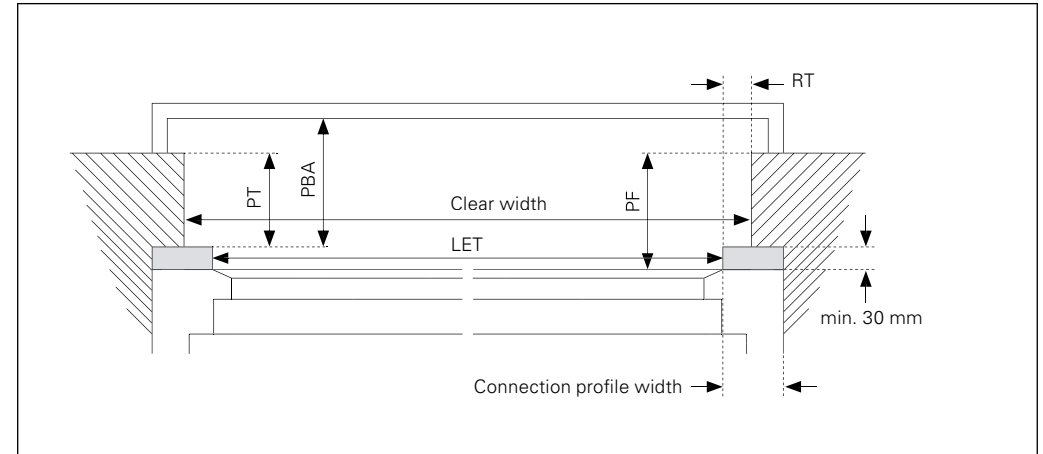

- LET = width between connection profiles (*Largeur Entre Tapées*)
- PT = reveal depth from connection profile to masonry (*Profondeur Tableau*)
- PBA = depth from connection profile to balcony (*Profondeur Barre Appui*)
- RT = visible width of connection profile (*Retombée de Tapée*)
- PF = reveal depth from window to masonry (*Profondeur Fenêtre*)

New installation note:

- ▶ The recess depth at the window must be at least 30 mm (the depth of the connection profile is always 30 mm!)

Measuring instructions | Horizontal section

PERSIENNE

5L-5R

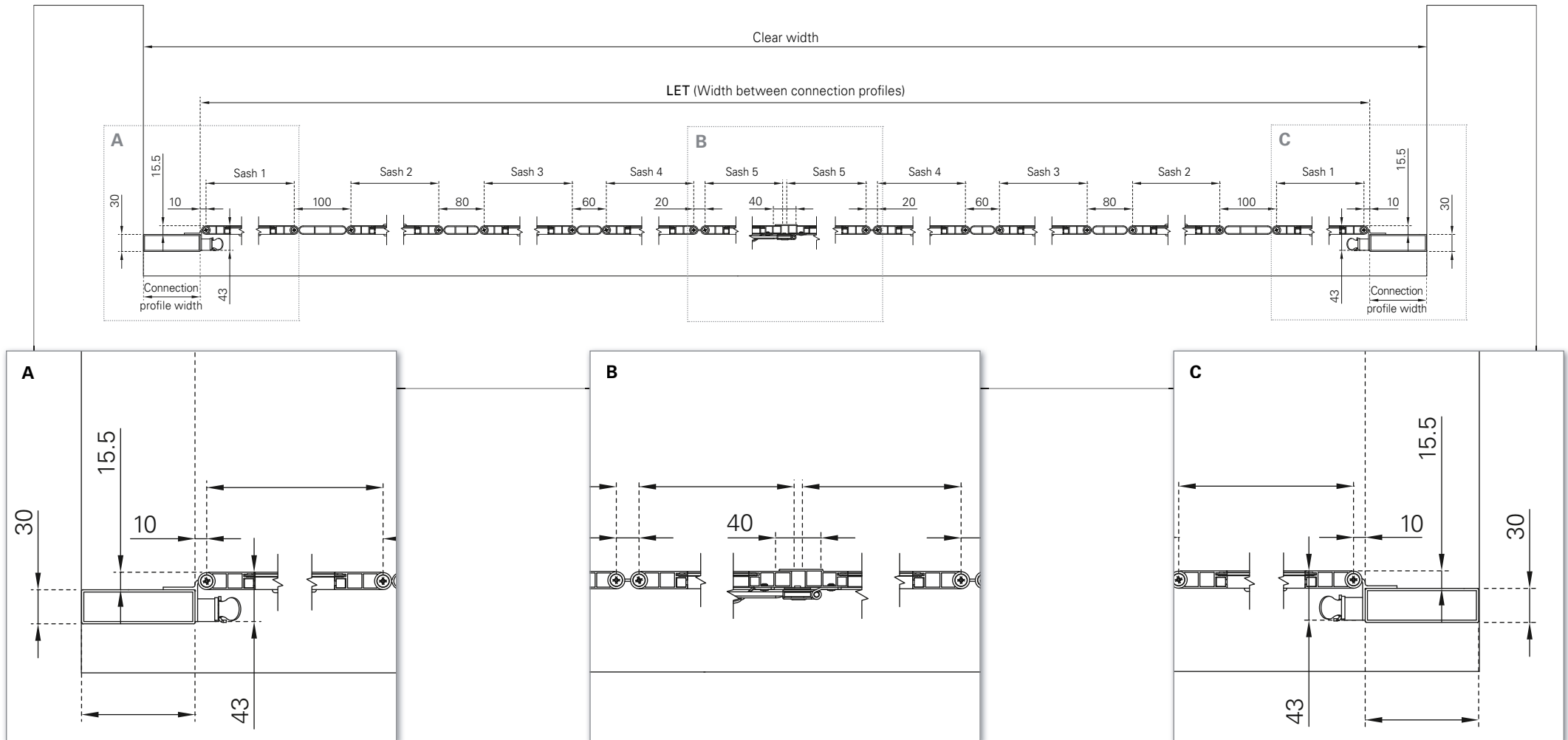

Measuring instructions | System cross-section | Vertical section

System cross-section

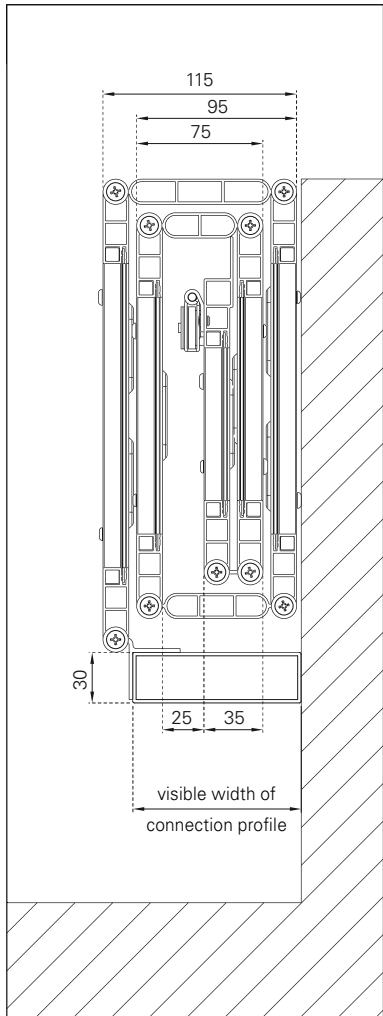

• package dimensions

Connection profile at the top and at the bottom

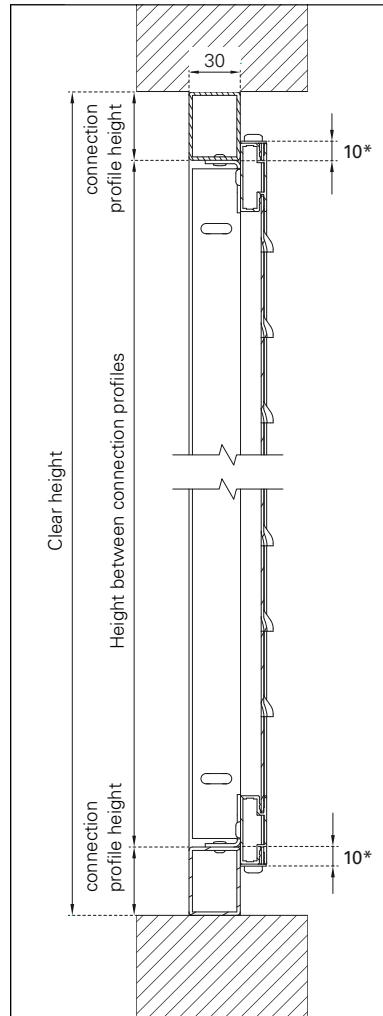

*fixed dimension

Connection profile only at the top

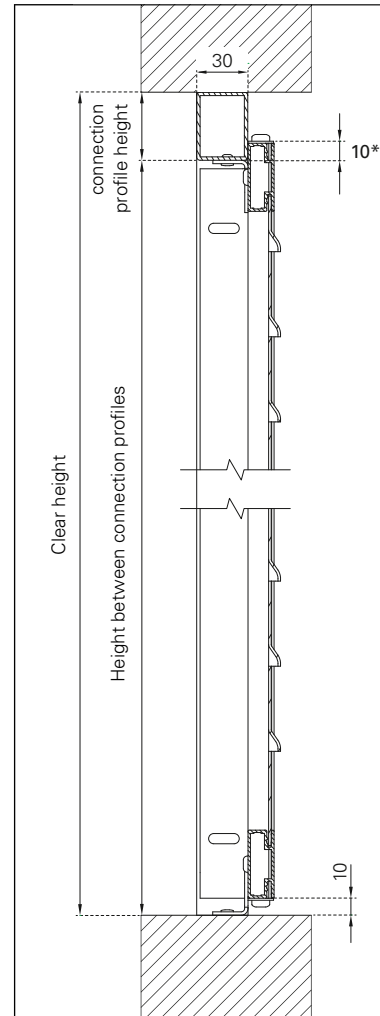

*fixed dimension

Without connection profile

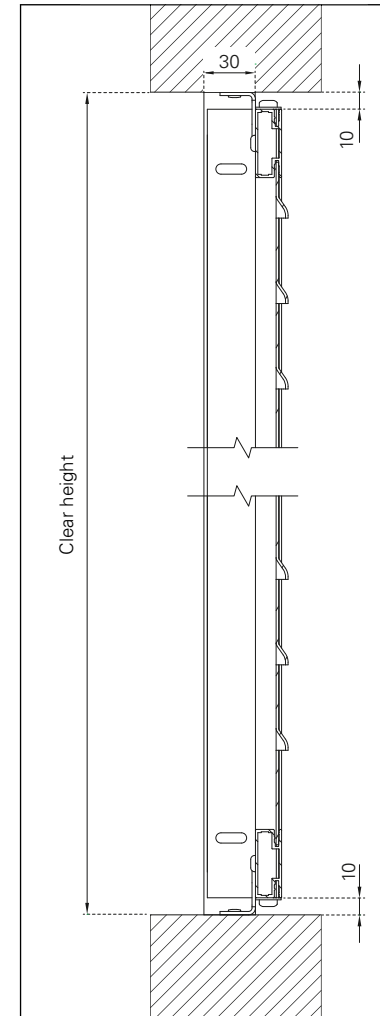

Connection profile heights

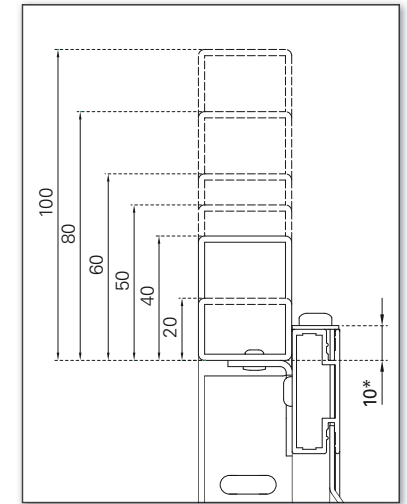

*The projection of the PERSIENNE frame onto the connection profile is always 10 mm

Measuring instructions | Closure handle height

Flat rotary rod

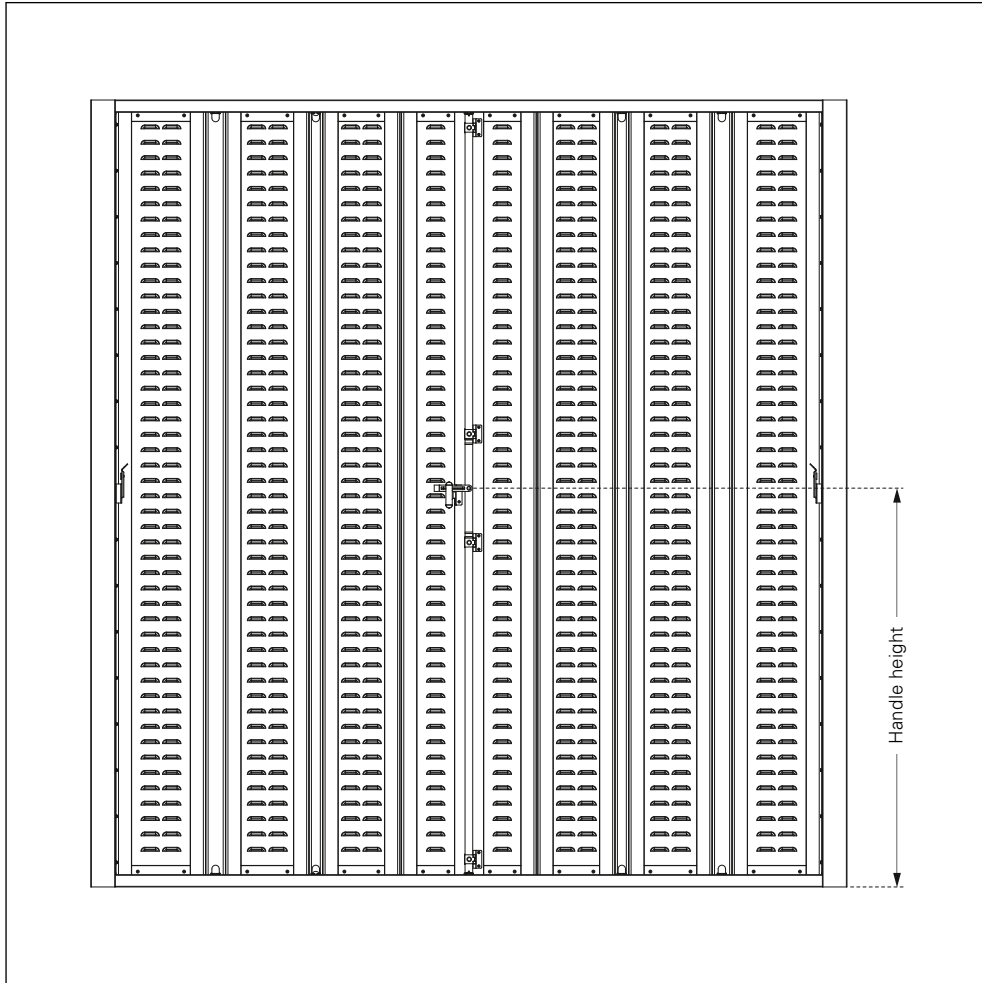

closed

Standard dimensions

Sash height	Standard handle height
700 – 1600 mm	500 mm
1601 – 2500 mm	1250 mm

PERSIENNE

Example 3L-3R

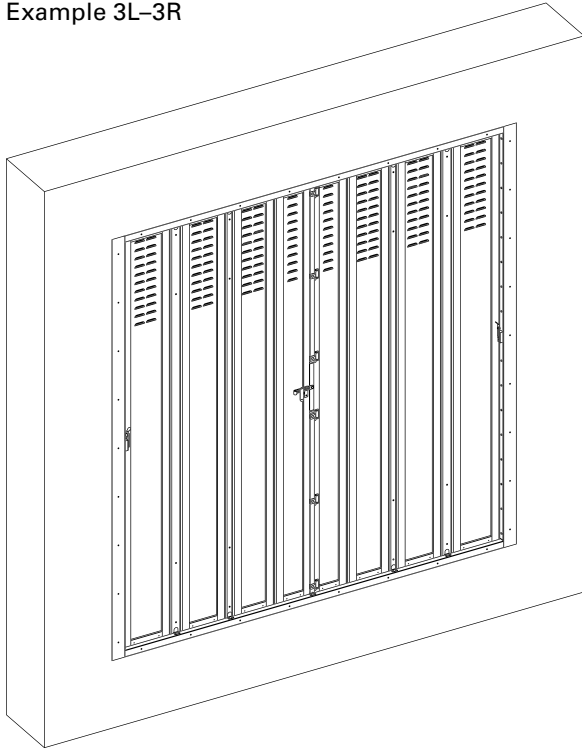

- Folding element for manual operation, comprised of sashes with louvred sheet metal or design variants.
- Belt profile (connection to connection profile) and espagnolette, pre-mounted on sash, shutter catch and stop angle enclosed separately.
- Folding element complete

Bolt option

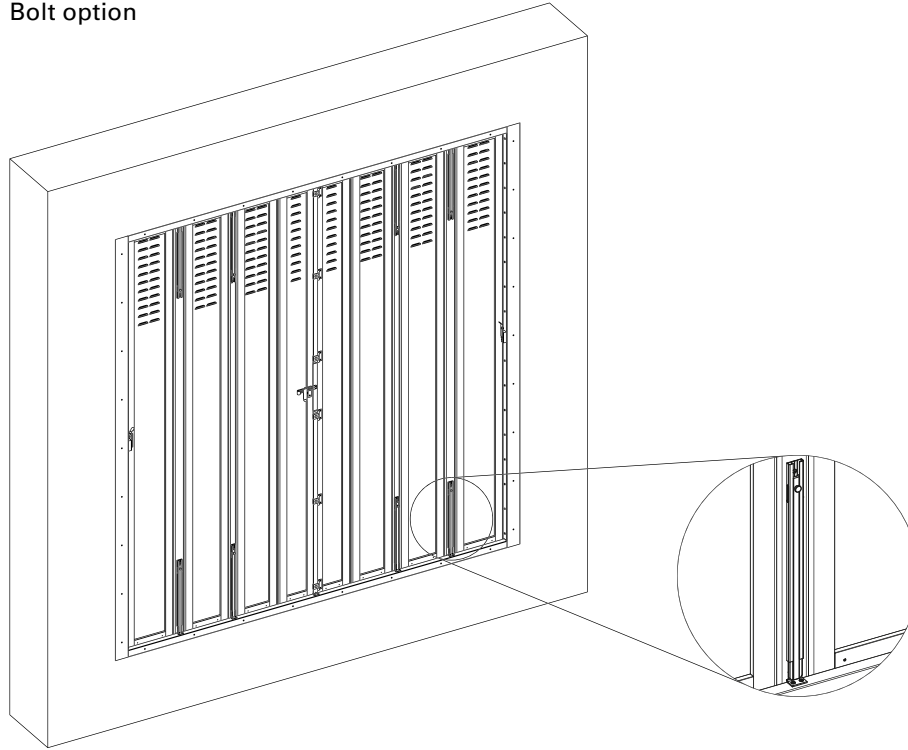

- Additional upwards and/or downwards locks
- Standard length 400 mm; optional 800 mm (e.g. for large sashes)
- Bolts on all joint profiles except for PE-G20
- Pre-assembled or packed loose

Options | Insert

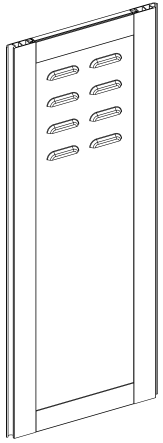

Louvres on the top third
Louvred panel, 1.5 mm,
grid 50 mm,
embossed (60×12×6 mm)

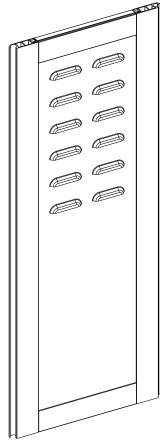

Louvres ½ from top
Louvred panel, 1.5 mm,
grid 50 mm,
embossed (60×12×6 mm)

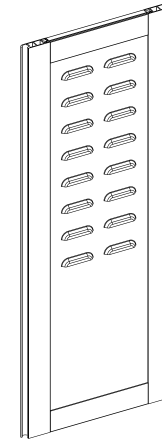

Louvres ⅔ from top
Louvred panel, 1.5 mm,
grid 50 mm,
embossed (60×12×6 mm)

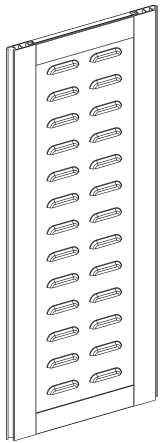

Continuous louvres
Louvred panel, 1.5 mm,
grid 50 mm,
embossed (60×12×6 mm)

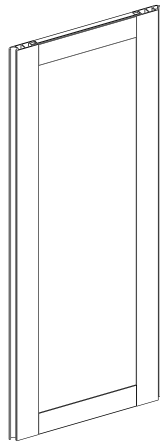

Closed panel
1.5 mm sheet metal insert

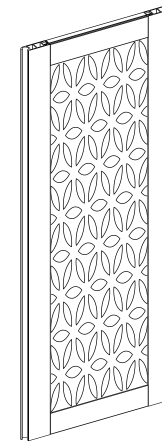

Individual design
1.5 mm sheet metal insert,
lasered design cutout
(data supplied by the customer)

INFO

- Shape template has to be in a ready-to-print file in either "dwg" or "dxf" file format.

Order form | PERSIENNE | Existing connection profile

Date _____ Page _____ of _____ Consignment _____

Your address and signature _____

Sash model _____

Persienne

Your customer number _____

Your processor _____

Preferred delivery date _____

Espagnolette enclosed pre-mounted

► Please enter bolt option on the extra page

	<input type="checkbox"/> OFFER	<input type="checkbox"/> ORDER
Surface		
Colour system		
Colour n°		
Frame	<input type="checkbox"/> FSM <input type="checkbox"/> Various	<input type="checkbox"/> RAL <input type="checkbox"/> NCS <input type="checkbox"/> VSR
Insert	<input type="checkbox"/> FSM <input type="checkbox"/> Various	<input type="checkbox"/> RAL <input type="checkbox"/> NCS <input type="checkbox"/> VSR
Fittings	<input type="checkbox"/> FSM <input type="checkbox"/> Various	<input type="checkbox"/> RAL <input type="checkbox"/> NCS <input type="checkbox"/> VSR
Stop angle	<input type="checkbox"/> FSM <input type="checkbox"/> Various	<input type="checkbox"/> RAL <input type="checkbox"/> NCS <input type="checkbox"/> VSR

► Deduction clearances are taken into consideration by EHRET as standard



Tel. +49 (0) 78 22/439-0
Fax +49 (0) 78 22/439-217
www.ehret.com

Follow-up order
The original order no. must be specified in the event of follow-up deliveries:

Position	Number of elements	Stop diagram	Clear dimensions				TJ width approx. from right reveal up to central joint (only if asymmetrical)	Connection profile				Handle height		Reveal depth			Insert							
			LET Width between connection profiles	Clear width	Height between connection profiles	Clear height		existing	2-sided left/right	at the top	at the bottom	Width on the left	Width on the right	Standard 500/250 mm	differing dimension specification	PT Connection profile to masonry	PBA Connection profile to balcony	PF Window to masonry	Louvers on the top third	Louvers 1/4 from top	Louvers 2/3 from top	Continuous louvers	Closed	Individual design customer data
								<input type="checkbox"/>	<input type="checkbox"/>	<input type="checkbox"/>	<input type="checkbox"/>			<input type="checkbox"/>					<input type="checkbox"/>	<input type="checkbox"/>	<input type="checkbox"/>	<input type="checkbox"/>	<input type="checkbox"/>	<input type="checkbox"/>
								<input type="checkbox"/>	<input type="checkbox"/>	<input type="checkbox"/>	<input type="checkbox"/>			<input type="checkbox"/>					<input type="checkbox"/>	<input type="checkbox"/>	<input type="checkbox"/>	<input type="checkbox"/>	<input type="checkbox"/>	<input type="checkbox"/>
								<input type="checkbox"/>	<input type="checkbox"/>	<input type="checkbox"/>	<input type="checkbox"/>			<input type="checkbox"/>					<input type="checkbox"/>	<input type="checkbox"/>	<input type="checkbox"/>	<input type="checkbox"/>	<input type="checkbox"/>	<input type="checkbox"/>
								<input type="checkbox"/>	<input type="checkbox"/>	<input type="checkbox"/>	<input type="checkbox"/>			<input type="checkbox"/>					<input type="checkbox"/>	<input type="checkbox"/>	<input type="checkbox"/>	<input type="checkbox"/>	<input type="checkbox"/>	<input type="checkbox"/>
								<input type="checkbox"/>	<input type="checkbox"/>	<input type="checkbox"/>	<input type="checkbox"/>			<input type="checkbox"/>					<input type="checkbox"/>	<input type="checkbox"/>	<input type="checkbox"/>	<input type="checkbox"/>	<input type="checkbox"/>	<input type="checkbox"/>
								<input type="checkbox"/>	<input type="checkbox"/>	<input type="checkbox"/>	<input type="checkbox"/>			<input type="checkbox"/>					<input type="checkbox"/>	<input type="checkbox"/>	<input type="checkbox"/>	<input type="checkbox"/>	<input type="checkbox"/>	<input type="checkbox"/>
								<input type="checkbox"/>	<input type="checkbox"/>	<input type="checkbox"/>	<input type="checkbox"/>			<input type="checkbox"/>					<input type="checkbox"/>	<input type="checkbox"/>	<input type="checkbox"/>	<input type="checkbox"/>	<input type="checkbox"/>	<input type="checkbox"/>
								<input type="checkbox"/>	<input type="checkbox"/>	<input type="checkbox"/>	<input type="checkbox"/>			<input type="checkbox"/>					<input type="checkbox"/>	<input type="checkbox"/>	<input type="checkbox"/>	<input type="checkbox"/>	<input type="checkbox"/>	<input type="checkbox"/>
								<input type="checkbox"/>	<input type="checkbox"/>	<input type="checkbox"/>	<input type="checkbox"/>			<input type="checkbox"/>					<input type="checkbox"/>	<input type="checkbox"/>	<input type="checkbox"/>	<input type="checkbox"/>	<input type="checkbox"/>	<input type="checkbox"/>

Order form | PERSIENNE | New installation

Date _____ Page _____ of _____

Consignment _____

Your address and signature _____

Sash model _____

Persienne

Espagnolette enclosed pre-mounted

Your customer number _____

Your processor _____

Preferred delivery date _____

Connection profile

Surface _____ Colour system _____ Colour N° _____

FSM RAL

Various NCS VSR

OFFER ORDER

Surface _____ Colour system _____ Colour n° _____

Frame FSM RAL Various NCS VSR

Insert FSM RAL Various NCS VSR

Fittings FSM RAL Various NCS VSR

Stop angle FSM RAL Various NCS VSR



Tel. +49 (0) 78 22/439-0
 Fax +49 (0) 78 22/439-217
 www.ehret.com

Follow-up order

The original order no. must be specified in the event of follow-up deliveries:

► Please enter bolt option on the extra page

► Deduction clearances are taken into consideration by EHRET as standard

Position	Number of elements	Stop diagram	Installation type		Clear dimensions		Connection profile										Handle height		Reveal depth			Insert					
			1 on the reveal	2 inset in the masonry	Clear width	Clear height	TJ width approx. from right reveal up to central joint	2-sided left/right	at the top	at the bottom	RT left Visible width of conn. profile on the left	RT right Visible width of conn. profile on the right	Width on the left 50/60/80/100 mm	Width on the right 50/60/80/100 mm	Height at the top 20/40/50/60/80/100 mm	Height at the bottom 20/40/50/60/80/100 mm	Standard 500/1250 mm differing dimension specification	PT Connection profile to masonry	PBA Connection profile to balcony	PF Window to masonry	Louvers on the top third	Louvers 1/2 from top	Louvers 2/3 from top	Continuous louvers	Closed	Individual design customer data	
			<input type="checkbox"/>	<input type="checkbox"/>				<input type="checkbox"/>	<input type="checkbox"/>	<input type="checkbox"/>						<input type="checkbox"/>				<input type="checkbox"/>	<input type="checkbox"/>	<input type="checkbox"/>	<input type="checkbox"/>	<input type="checkbox"/>	<input type="checkbox"/>	<input type="checkbox"/>	<input type="checkbox"/>
			<input type="checkbox"/>	<input type="checkbox"/>				<input type="checkbox"/>	<input type="checkbox"/>	<input type="checkbox"/>						<input type="checkbox"/>				<input type="checkbox"/>	<input type="checkbox"/>	<input type="checkbox"/>	<input type="checkbox"/>	<input type="checkbox"/>	<input type="checkbox"/>	<input type="checkbox"/>	<input type="checkbox"/>
			<input type="checkbox"/>	<input type="checkbox"/>				<input type="checkbox"/>	<input type="checkbox"/>	<input type="checkbox"/>						<input type="checkbox"/>				<input type="checkbox"/>	<input type="checkbox"/>	<input type="checkbox"/>	<input type="checkbox"/>	<input type="checkbox"/>	<input type="checkbox"/>	<input type="checkbox"/>	<input type="checkbox"/>
			<input type="checkbox"/>	<input type="checkbox"/>				<input type="checkbox"/>	<input type="checkbox"/>	<input type="checkbox"/>						<input type="checkbox"/>				<input type="checkbox"/>	<input type="checkbox"/>	<input type="checkbox"/>	<input type="checkbox"/>	<input type="checkbox"/>	<input type="checkbox"/>	<input type="checkbox"/>	<input type="checkbox"/>
			<input type="checkbox"/>	<input type="checkbox"/>				<input type="checkbox"/>	<input type="checkbox"/>	<input type="checkbox"/>						<input type="checkbox"/>				<input type="checkbox"/>	<input type="checkbox"/>	<input type="checkbox"/>	<input type="checkbox"/>	<input type="checkbox"/>	<input type="checkbox"/>	<input type="checkbox"/>	<input type="checkbox"/>
			<input type="checkbox"/>	<input type="checkbox"/>				<input type="checkbox"/>	<input type="checkbox"/>	<input type="checkbox"/>						<input type="checkbox"/>				<input type="checkbox"/>	<input type="checkbox"/>	<input type="checkbox"/>	<input type="checkbox"/>	<input type="checkbox"/>	<input type="checkbox"/>	<input type="checkbox"/>	<input type="checkbox"/>
			<input type="checkbox"/>	<input type="checkbox"/>				<input type="checkbox"/>	<input type="checkbox"/>	<input type="checkbox"/>						<input type="checkbox"/>				<input type="checkbox"/>	<input type="checkbox"/>	<input type="checkbox"/>	<input type="checkbox"/>	<input type="checkbox"/>	<input type="checkbox"/>	<input type="checkbox"/>	<input type="checkbox"/>
			<input type="checkbox"/>	<input type="checkbox"/>				<input type="checkbox"/>	<input type="checkbox"/>	<input type="checkbox"/>						<input type="checkbox"/>				<input type="checkbox"/>	<input type="checkbox"/>	<input type="checkbox"/>	<input type="checkbox"/>	<input type="checkbox"/>	<input type="checkbox"/>	<input type="checkbox"/>	<input type="checkbox"/>
			<input type="checkbox"/>	<input type="checkbox"/>				<input type="checkbox"/>	<input type="checkbox"/>	<input type="checkbox"/>						<input type="checkbox"/>				<input type="checkbox"/>	<input type="checkbox"/>	<input type="checkbox"/>	<input type="checkbox"/>	<input type="checkbox"/>	<input type="checkbox"/>	<input type="checkbox"/>	<input type="checkbox"/>

EHRET GmbH

Bahnhofstrasse 14-18

77972 Mahlberg, Germany

Tel. +49(0) 78 22/439-0

Fax +49(0) 78 22/439-116

www.ehret.com

Made in Germany

© 05.2021 EHRET GmbH | F28.E | Subject to technical modifications