

Porta per garage



Moduli di ordinazione  
e scheda tecnica

# Schemi di posa

Le viste sono dall'interno!

- Consideriamo le quote di deduzione (distanza tra larghezza libera e larghezza persiana a battente) quote standard.

apertura verso l'esterno

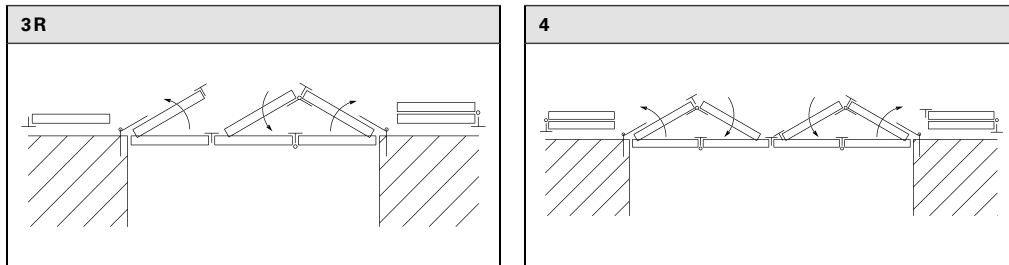
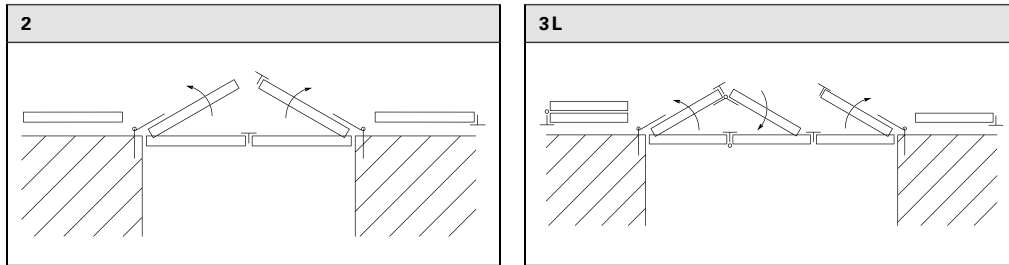
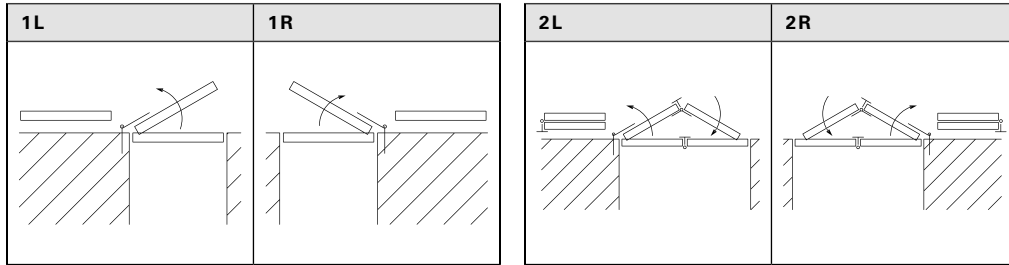

apertura verso l'interno

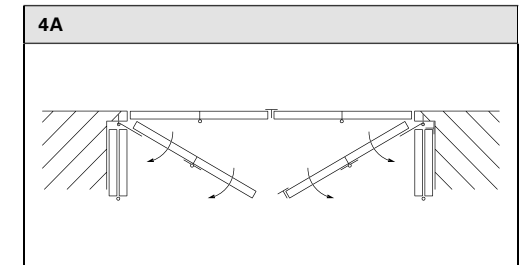
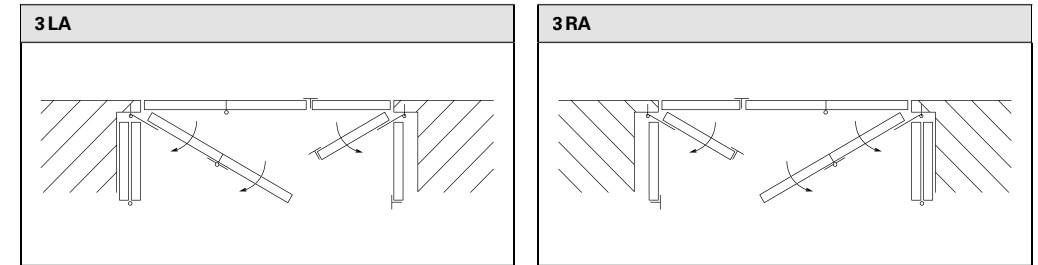
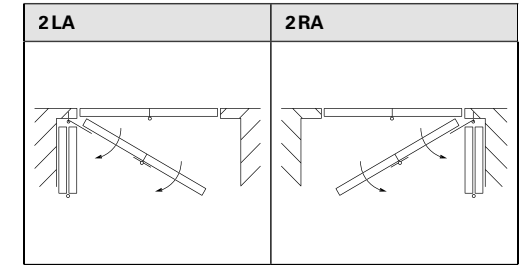

- *Attenzione: ante asimmetriche!*

# Istruzioni di misurazione

Rilevamento della misura con larghezza/altezza libera e schema di posa

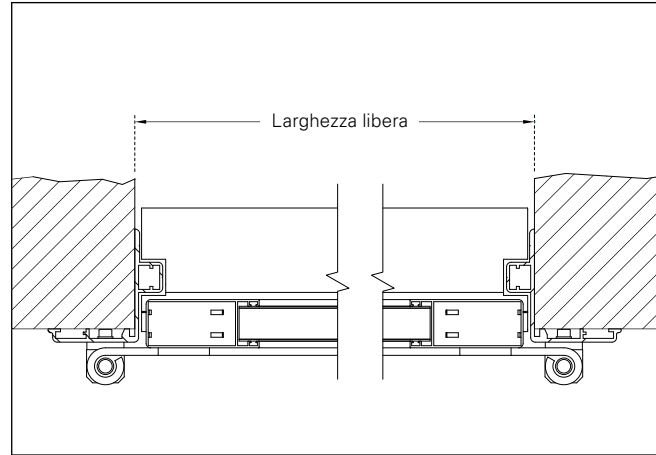
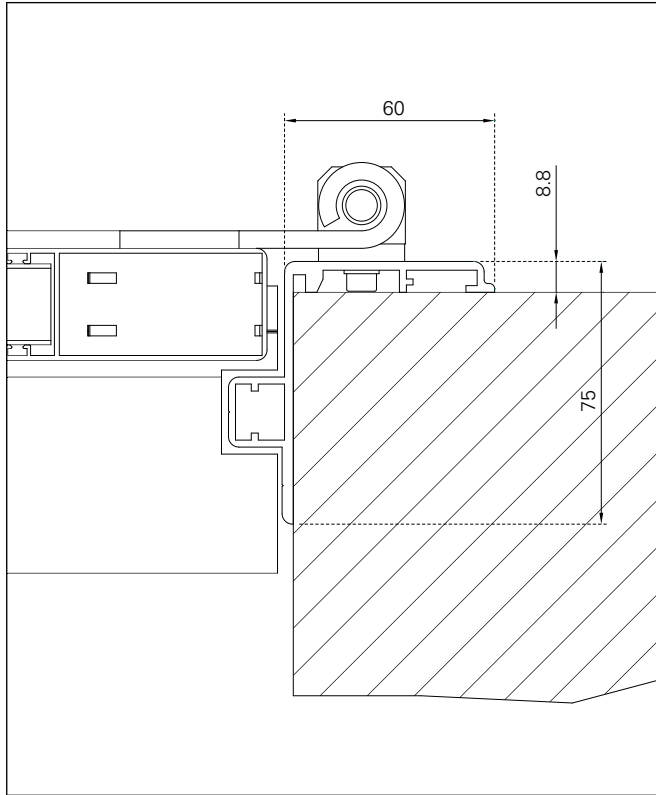

Opzione prolunga intelaiatura (1-120 mm)

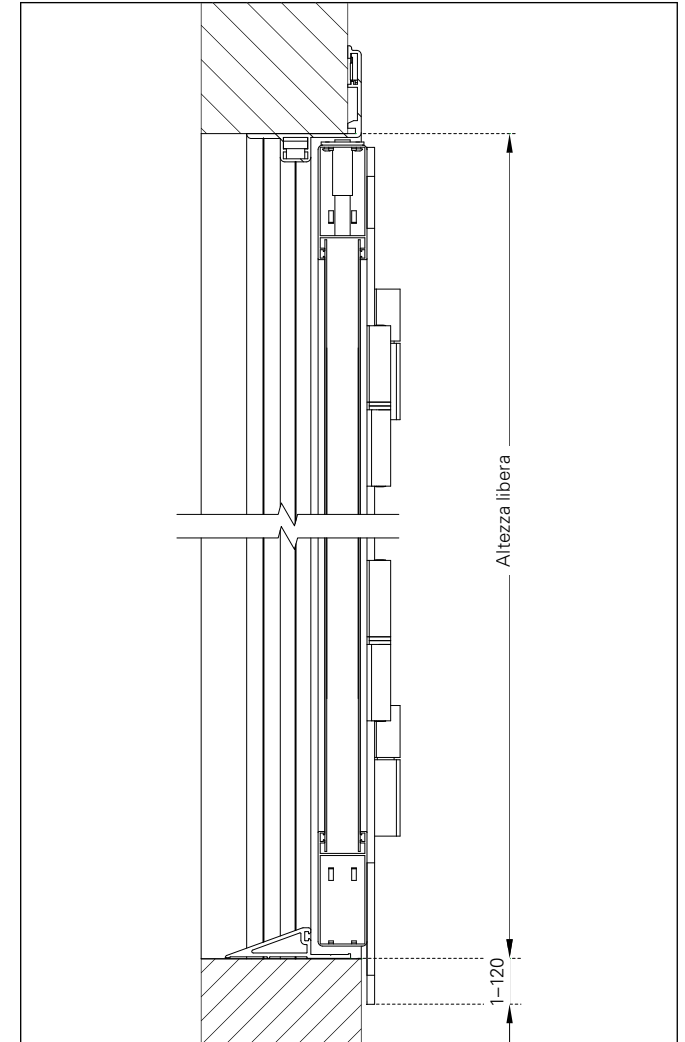
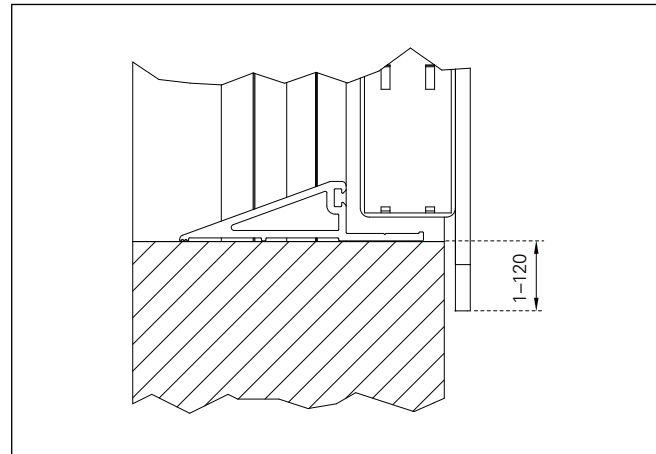

## Quote di deduzione (di EHRET)

- Larghezza libera: -10mm
- Altezza libera 3 lati: -5mm

Le quote di deduzione (distanza tra larghezza libera e larghezza persiana a battente) indicate sono considerate standard.

# Istruzioni di misurazione

Intelaiatura montata dall'esterno / apertura verso l'esterno

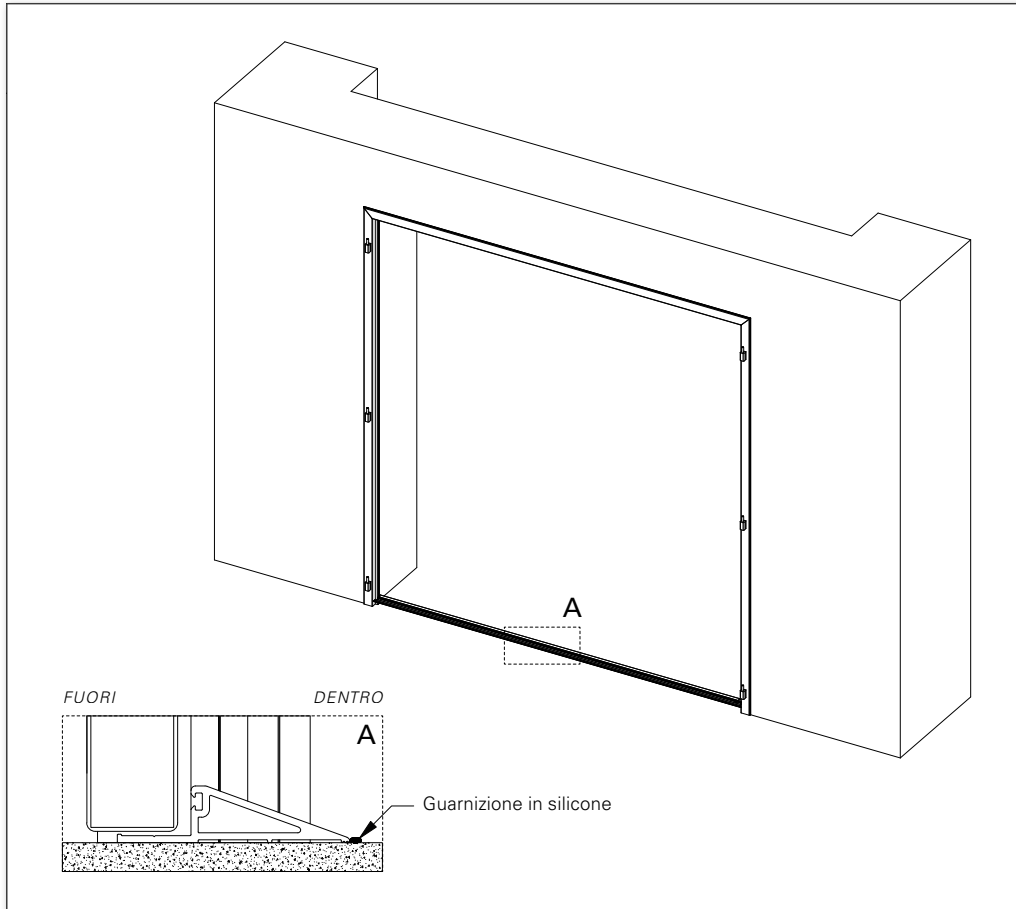

Intelaiatura montata dall'interno / apertura verso l'interno

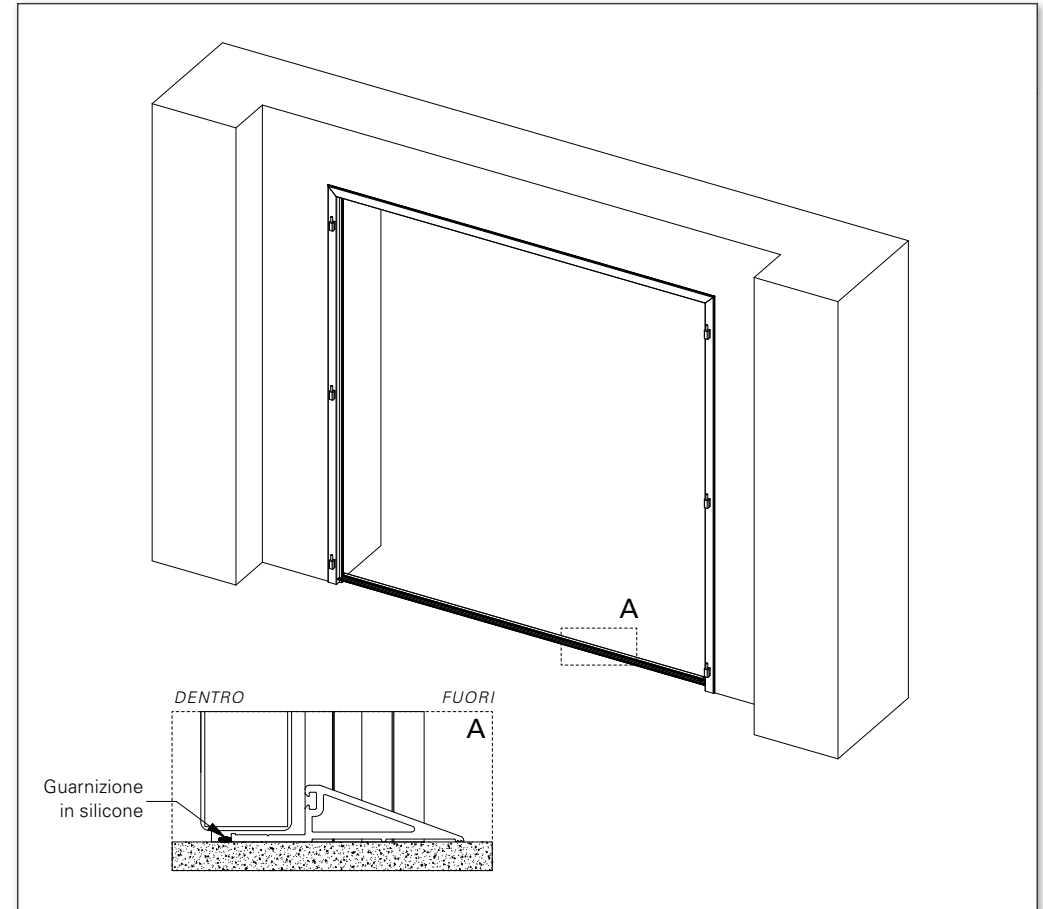

Larghezza libera	Altezza libera
500 – 2800 mm	800 – 2500 mm

# Montaggio preliminare e ferramenta

## Ferramenta ante

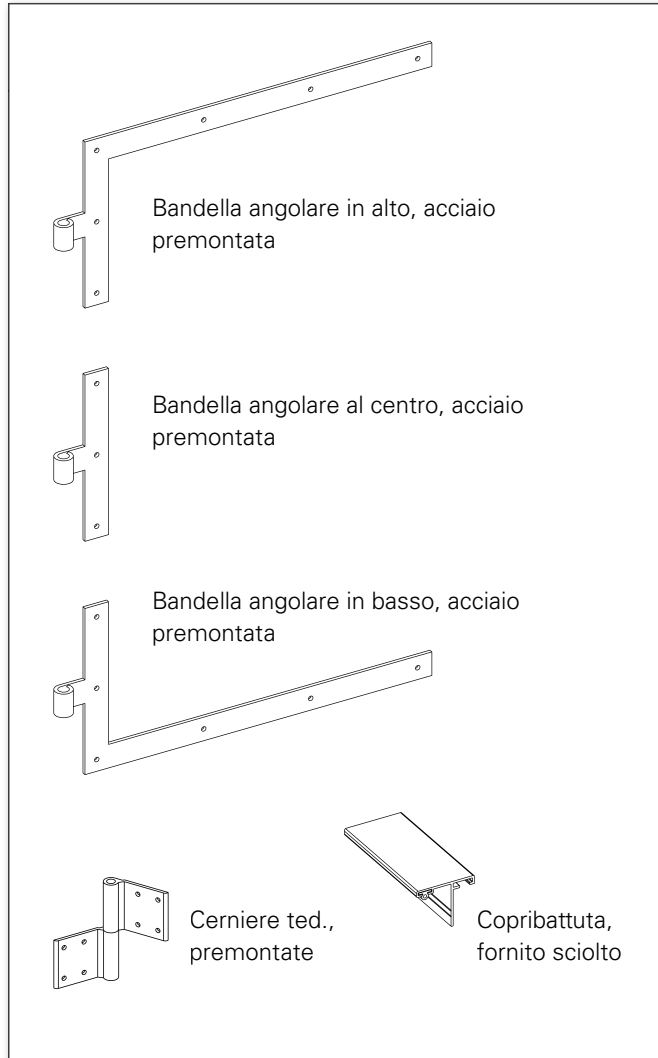

## Montaggio preliminare chiusura

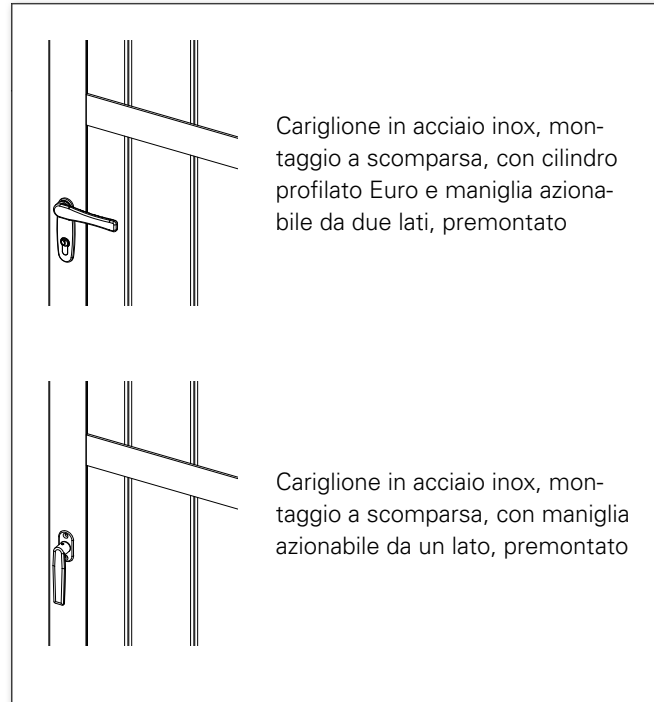

## Montaggio preliminare arresto



## Opzione arresto aggiuntivo, fornito sciolto

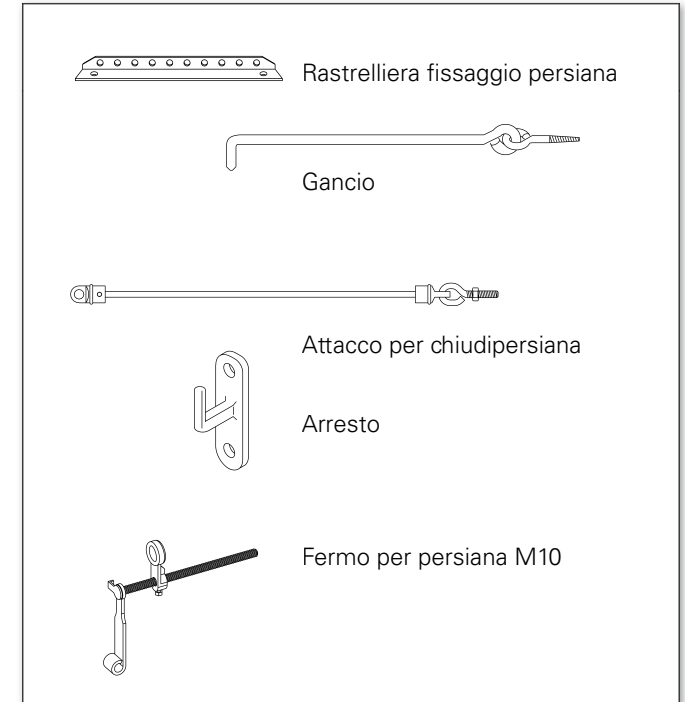

## Accessori opzionali



# Apertura vetro

## Varianti

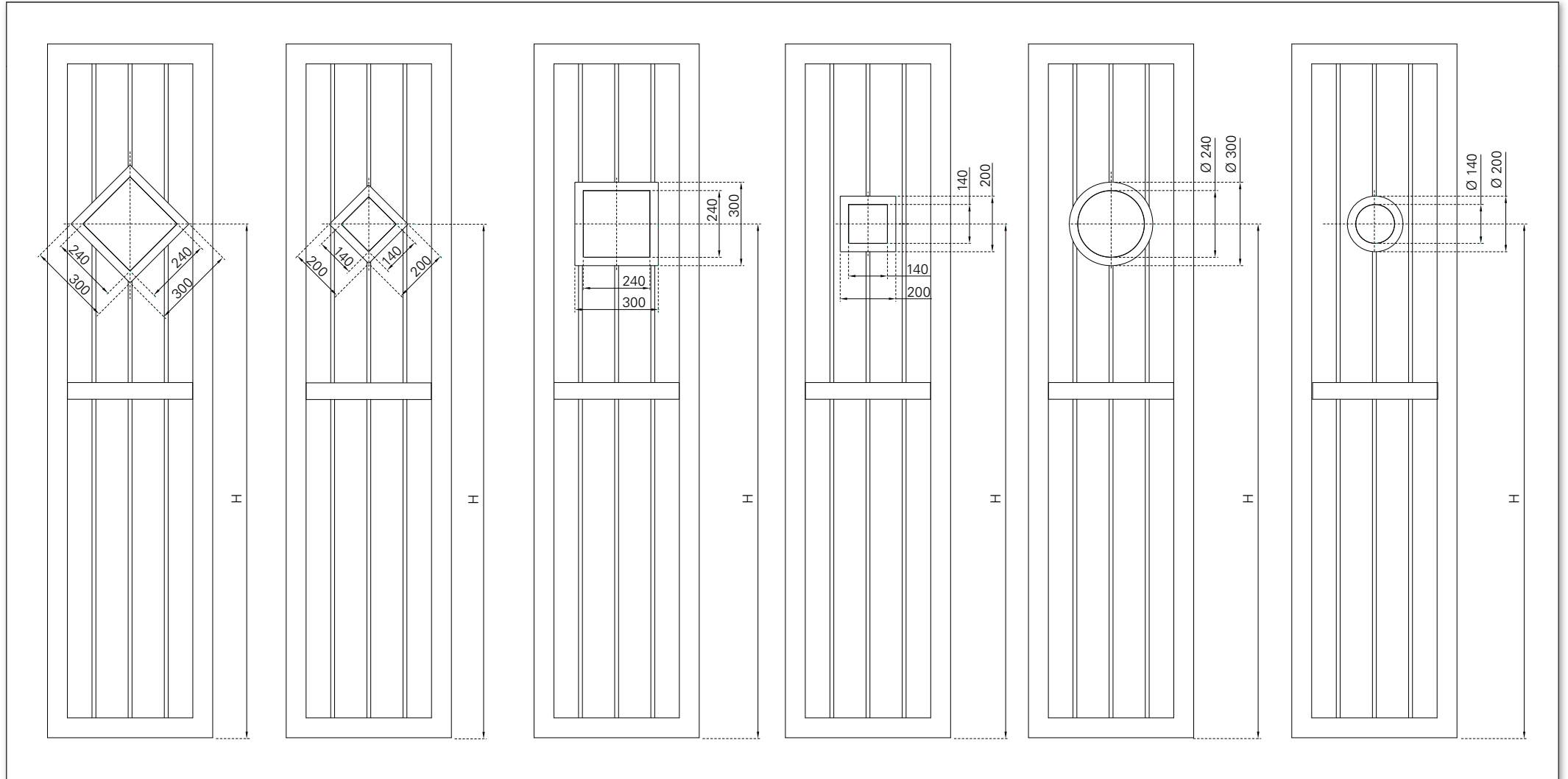

• H = Altezza apertura vetro

# Inserto apertura vetro

## Apertura vetro

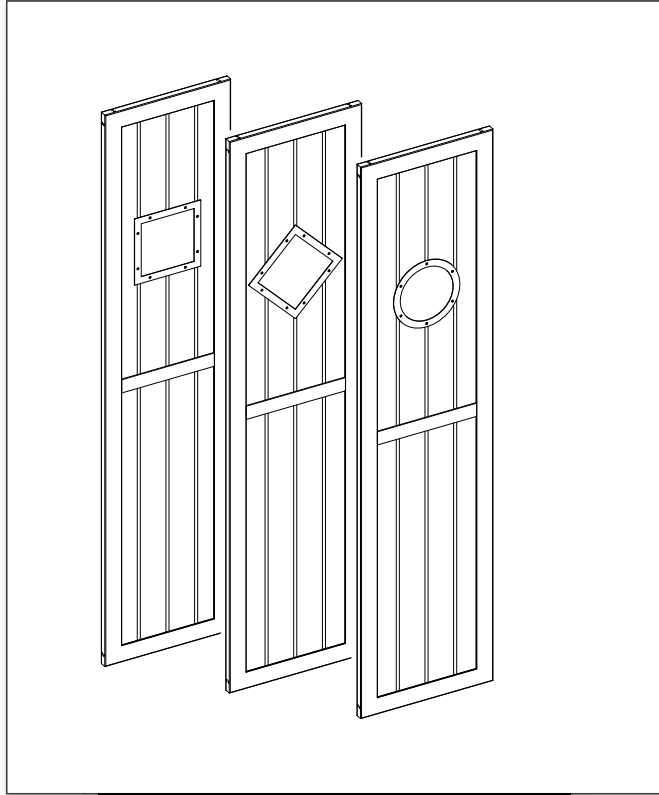

### Vetro acrilico inserto

- chiaro
- opaco
- fumé

### Forma apertura vetro

- circolare
- quadrata
- romboidale

### Misure esterne cornice dell'inserto

- Cerchio  $\varnothing 200$  mm
- Cerchio  $\varnothing 300$  mm
- Quadrato  $200 \times 200$  mm
- Quadrato  $300 \times 300$  mm
- Rombo  $200 \times 200$  mm
- Rombo  $300 \times 300$  mm

# Modulo di ordinazione | Porta per garage

Data \_\_\_\_\_ pagina \_\_\_\_\_ di \_\_\_\_\_  
 Indirizzo e firma \_\_\_\_\_

Codice cliente \_\_\_\_\_  
 Addetto \_\_\_\_\_  
 Termine di consegna desiderato \_\_\_\_\_

Commissione \_\_\_\_\_

Modello di persiana  TSW-Q  
 TSW-RS-Q  
 TSW-RW-Q

Ocean Line plus  sì  
 Montaggio preliminare  sì

	<input type="checkbox"/> OFFERTA	<input type="checkbox"/> ORDINE
	<i>Superficie</i>	<i>Sistema</i>
Intelaiatura	<input type="checkbox"/> FSM* <input type="checkbox"/> Finitura <input type="checkbox"/> Varie	<input type="checkbox"/> RAL <input type="checkbox"/> NCS <input type="checkbox"/> VSR
Ante	<input type="checkbox"/> FSM* <input type="checkbox"/> Finitura <input type="checkbox"/> Varie	<input type="checkbox"/> RAL <input type="checkbox"/> NCS <input type="checkbox"/> VSR
Telaio	<input type="checkbox"/> FSM* <input type="checkbox"/> Finitura <input type="checkbox"/> Varie	<input type="checkbox"/> RAL <input type="checkbox"/> NCS <input type="checkbox"/> VSR
Ferramenta	<input type="checkbox"/> FSM* <input type="checkbox"/> Varie	<input type="checkbox"/> RAL <input type="checkbox"/> NCS <input type="checkbox"/> VSR

*\*struttura fine e opaca*



Tel. +49 (0) 78 22/439-0  
 Fax +49 (0) 78 22/439-217  
 www.ehret.com

\_\_\_\_\_  
 \_\_\_\_\_  
 \_\_\_\_\_

**Ordinazione successiva**  
 in caso di forniture successive indicare assolutamente il n. ordine originario:  
 \_\_\_\_\_

► si prega di inserire la ferramenta aggiuntiva opzionale nella pagina apposta!

Pos.	Schema di posa	Quote libere		apertura verso l'esterno	apertura verso l'interno	Inserto						Altezza Apertura vetro	Opzione prolunga intelaiatura 1-120 mm	Vetro acrilico			Ferramenta				Varie	
		Larghezza libera in mm	Altezza libera in mm			Cerchio Ø 200 mm	Cerchio Ø 300 mm	Quadrato 200x200 mm	Quadrato 300x300 mm	Rombo 200x200 mm	Rombo 300x300 mm			chiaro	opaco	fumé	Cremagliera e gancio antiventto	Chiudipersiana e cardini angolari	Fermo M10	Set di impermeabilizzazione per intelaiature rapide		
				<input type="checkbox"/>	<input type="checkbox"/>	<input type="checkbox"/>	<input type="checkbox"/>	<input type="checkbox"/>	<input type="checkbox"/>	<input type="checkbox"/>	<input type="checkbox"/>	<input type="checkbox"/>	<input type="checkbox"/>	<input type="checkbox"/>	<input type="checkbox"/>	<input type="checkbox"/>	<input type="checkbox"/>	<input type="checkbox"/>	<input type="checkbox"/>	<input type="checkbox"/>	<input type="checkbox"/>	
				<input type="checkbox"/>	<input type="checkbox"/>	<input type="checkbox"/>	<input type="checkbox"/>	<input type="checkbox"/>	<input type="checkbox"/>	<input type="checkbox"/>	<input type="checkbox"/>	<input type="checkbox"/>	<input type="checkbox"/>	<input type="checkbox"/>	<input type="checkbox"/>	<input type="checkbox"/>	<input type="checkbox"/>	<input type="checkbox"/>	<input type="checkbox"/>	<input type="checkbox"/>	<input type="checkbox"/>	
				<input type="checkbox"/>	<input type="checkbox"/>	<input type="checkbox"/>	<input type="checkbox"/>	<input type="checkbox"/>	<input type="checkbox"/>	<input type="checkbox"/>	<input type="checkbox"/>	<input type="checkbox"/>	<input type="checkbox"/>	<input type="checkbox"/>	<input type="checkbox"/>	<input type="checkbox"/>	<input type="checkbox"/>	<input type="checkbox"/>	<input type="checkbox"/>	<input type="checkbox"/>	<input type="checkbox"/>	
				<input type="checkbox"/>	<input type="checkbox"/>	<input type="checkbox"/>	<input type="checkbox"/>	<input type="checkbox"/>	<input type="checkbox"/>	<input type="checkbox"/>	<input type="checkbox"/>	<input type="checkbox"/>	<input type="checkbox"/>	<input type="checkbox"/>	<input type="checkbox"/>	<input type="checkbox"/>	<input type="checkbox"/>	<input type="checkbox"/>	<input type="checkbox"/>	<input type="checkbox"/>	<input type="checkbox"/>	
				<input type="checkbox"/>	<input type="checkbox"/>	<input type="checkbox"/>	<input type="checkbox"/>	<input type="checkbox"/>	<input type="checkbox"/>	<input type="checkbox"/>	<input type="checkbox"/>	<input type="checkbox"/>	<input type="checkbox"/>	<input type="checkbox"/>	<input type="checkbox"/>	<input type="checkbox"/>	<input type="checkbox"/>	<input type="checkbox"/>	<input type="checkbox"/>	<input type="checkbox"/>	<input type="checkbox"/>	
				<input type="checkbox"/>	<input type="checkbox"/>	<input type="checkbox"/>	<input type="checkbox"/>	<input type="checkbox"/>	<input type="checkbox"/>	<input type="checkbox"/>	<input type="checkbox"/>	<input type="checkbox"/>	<input type="checkbox"/>	<input type="checkbox"/>	<input type="checkbox"/>	<input type="checkbox"/>	<input type="checkbox"/>	<input type="checkbox"/>	<input type="checkbox"/>	<input type="checkbox"/>	<input type="checkbox"/>	
				<input type="checkbox"/>	<input type="checkbox"/>	<input type="checkbox"/>	<input type="checkbox"/>	<input type="checkbox"/>	<input type="checkbox"/>	<input type="checkbox"/>	<input type="checkbox"/>	<input type="checkbox"/>	<input type="checkbox"/>	<input type="checkbox"/>	<input type="checkbox"/>	<input type="checkbox"/>	<input type="checkbox"/>	<input type="checkbox"/>	<input type="checkbox"/>	<input type="checkbox"/>	<input type="checkbox"/>	
				<input type="checkbox"/>	<input type="checkbox"/>	<input type="checkbox"/>	<input type="checkbox"/>	<input type="checkbox"/>	<input type="checkbox"/>	<input type="checkbox"/>	<input type="checkbox"/>	<input type="checkbox"/>	<input type="checkbox"/>	<input type="checkbox"/>	<input type="checkbox"/>	<input type="checkbox"/>	<input type="checkbox"/>	<input type="checkbox"/>	<input type="checkbox"/>	<input type="checkbox"/>	<input type="checkbox"/>	
				<input type="checkbox"/>	<input type="checkbox"/>	<input type="checkbox"/>	<input type="checkbox"/>	<input type="checkbox"/>	<input type="checkbox"/>	<input type="checkbox"/>	<input type="checkbox"/>	<input type="checkbox"/>	<input type="checkbox"/>	<input type="checkbox"/>	<input type="checkbox"/>	<input type="checkbox"/>	<input type="checkbox"/>	<input type="checkbox"/>	<input type="checkbox"/>	<input type="checkbox"/>	<input type="checkbox"/>	
				<input type="checkbox"/>	<input type="checkbox"/>	<input type="checkbox"/>	<input type="checkbox"/>	<input type="checkbox"/>	<input type="checkbox"/>	<input type="checkbox"/>	<input type="checkbox"/>	<input type="checkbox"/>	<input type="checkbox"/>	<input type="checkbox"/>	<input type="checkbox"/>	<input type="checkbox"/>	<input type="checkbox"/>	<input type="checkbox"/>	<input type="checkbox"/>	<input type="checkbox"/>	<input type="checkbox"/>	





**EHRET GmbH**

Bahnhofstrasse 14-18

D-77972 Mahlberg

Tel. +49(0) 78 22/439-0

Fax +49(0) 78 22/439-116

[www.ehret.com](http://www.ehret.com)

Made in Germany

© 08.2020 EHRET GmbH | F32.1 | Con riserva di modifiche tecniche